



2024+ Ford
Mustang GT 5.0L Active



IMPORTANT! WARRANTY AND INSTALLATION INSTRUCTIONS

Please Forward All Information to Consumer

Be sure to review the enclosed instructions prior to beginning the installation process. If you have any questions about the enclosed parts or instructions, or if you encounter a problem during installation:

CALL TECHNICAL SUPPORT: 440.891.0999 or 800.486.0999

**TO ACTIVATE YOUR WARRANTY GO TO:
[CORSAPERFORMANCE.COM/WARRANTY](https://corsaperformance.com/warranty)**

COLOR INSTRUCTIONS ARE AVAILABLE BY PART NUMBER ON: [CORSAPERFORMANCE.COM](https://corsaperformance.com)



NEVER work on a hot exhaust system.
Allow time for the vehicle to cool.

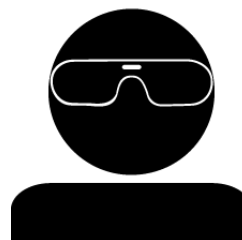

**Always wear eye protection
when working under a vehicle.**

INSTALL DIFFICULTY

RECOMMENDED TOOLS & SUPPLIES

- 3/8" Drive Ratchet
- 3/8" Drive Torque Wrench
- 3/8" Drive 13mm Socket
- 3/8" Drive 15mm Deep Socket
- Grommet Pullers
- Soap and Water Solution
- Push Clip Removal Tool/Flat Head Screwdriver
- 1/4" Drive Ratchet
- 1/4" Drive 7mm Socket
- 1/4" Drive 10mm Socket
- 1/4" Drive 11mm Socket
- Torque Wrench
- Penetrating Lubricant Spray
- Masking Tape & Marker

2024+ FORD MUSTANG GT 5.0L V8

3.0" Active Cat-Back - Dual Rear Exit w/ Twin 4.0" Tips

Part #: 21259, 21260 (Incl. BLK)



Please take time to read and understand these installation instructions.

CORSA recommends that the installation of this system be performed by a qualified service center or professional installer who has the necessary equipment, tools, and experienced personnel. However, if you decide to perform this installation yourself, the use of an additional person may be required.

WARNING: Never work on a hot exhaust system. Allow time for the vehicle to cool. Always wear eye protection when working under a vehicle.

CORSA Performance makes no representation or warranty, expressed or implied that its downpipe or header products and or components there-in comply with federal, state or local emission levels, noise levels, or safety standards or that any of their parts conform with the racing vehicles exemption, unless otherwise noted. The purchaser assumes all responsibility for such use and compliance.

This warranty does not extend to damaged or defect in the finish of a product or to any product, that in the opinion of CORSA Performance, has been misused, damaged by accident or negligence, altered or modified in any way, faulty installation or installed contrary to CORSA installation instructions, or repaired by an unauthorized service facility.

Full warranty available on www.corsaperformance.com

Please confirm that all parts are present according to the bill of materials before beginning the installation.

If something is missing call Tech Support at 440.891.099 or Toll Free: 1.800.486.0999

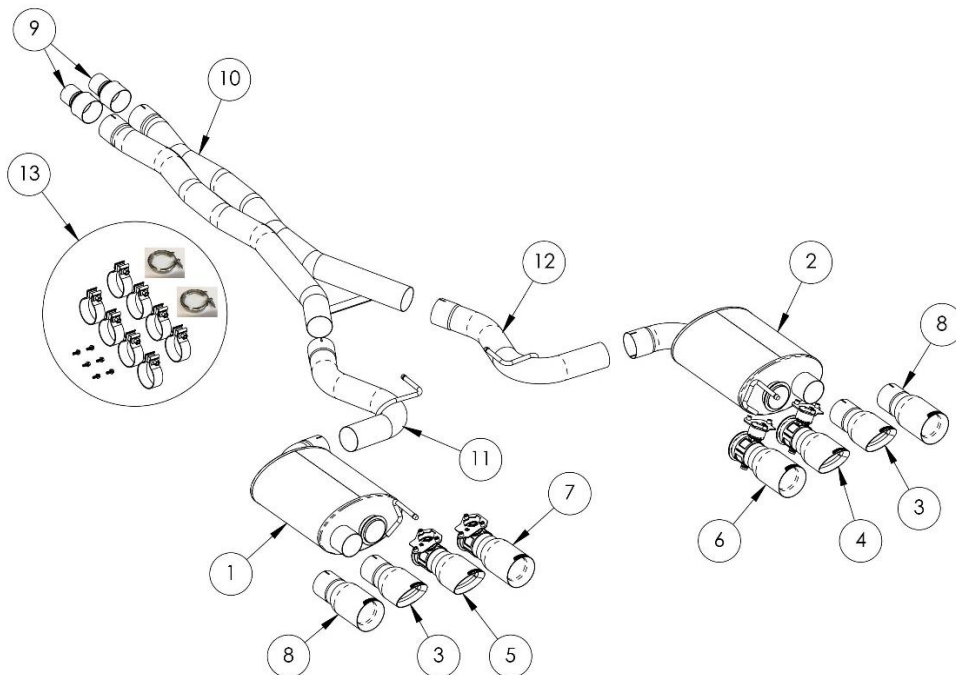

NOTE: Each Kit Includes 1 set of tips

BILL OF MATERIALS

1.	Driver Active Muffler Assembly (20MU2154)	2.	Passenger Active Muffler Assembly (20MU2155)
3.	Outer 4.0" Slash Cut Non-Valved Tip Assembly (2) (20MU3018)	4.	Passenger 4.0" Slash Cut Valved Tip Assembly (20MU3031)
5.	Driver 4.0" Slash Cut Valved Tip Assembly (20MU3032)	6.	Passenger 4.0" Straight Cut Valved Tip Assembly (20MU3033)
7.	Driver 4.0" Straight Cut Valved Tip Assembly (20MU3034)	8.	Outer 4.0" Straight Cut Non-Valved Tip Assembly (2) (20MU3035)
9.	X-Pipe Inlet to Stock Adapter (2) (20MU4076)	10.	Double X-Pipe Assembly (20MU4078)
11.	Driver Axle Pipe Assembly (20MU4250)	12.	Passenger Axle Pipe Assembly (20MU4251)
13.	Hardware Kit (20MU7086)		

CAUTION: Never work on a hot exhaust system. Allow the vehicle to cool for at least an hour and a half. Always wear eye protection when working under a vehicle. It is recommended to use cotton gloves to protect stainless steel surfaces from permanent grease and oil stains.

REMOVAL INSTRUCTIONS

FACTORY EXHAUST



1. The rear under tray is secured by two push clips, one 10mm bolt, and seven 7mm bolts. Use a 1/4" drive ratchet and 10mm socket to remove the bolt securing the center of the rear under tray. Next, remove the two push clips using a removal tool or flat head screwdriver.



2. Use a 1/4" drive ratchet and 7mm socket to remove the two bolts securing the forward end of the rear under tray.



3. Use a 1/4" drive ratchet and 7mm socket to remove the five bolts securing the rearward end of the rear under tray to free it from the vehicle. **Set aside the rear under tray and fasteners in a protected location to be reused in INSTALL STEP 23.**



4. Use a 3/8" drive ratchet and 13mm socket to remove the two bolts securing the rear under tray mounting bracket to the chassis; this will free it from the vehicle. **Set aside the rear under tray mounting bracket and the fasteners in a protected location to be reused in INSTALL STEP 13.**

Continued on Next Page . . .

REMOVAL INSTRUCTIONS

FACTORY EXHAUST



- 5.** Use a push clip removal tool (or a flat head screwdriver) to remove the driver and passenger side Christmas tree fasteners (holding the valve actuator wiring harnesses to the anchor brackets) from the exhaust valves.



- 6.** Unplug the wiring harness from the exhaust valve actuators located on the inner most driver and passenger tips. To release the plug, slide the white locking clip away from the actuator, press down on the clip and slide the plug away from the actuator.



- 7.** Both the driver and passenger side valve wiring harness connections should now be disconnected and hanging clear of the stock rear mufflers as shown.

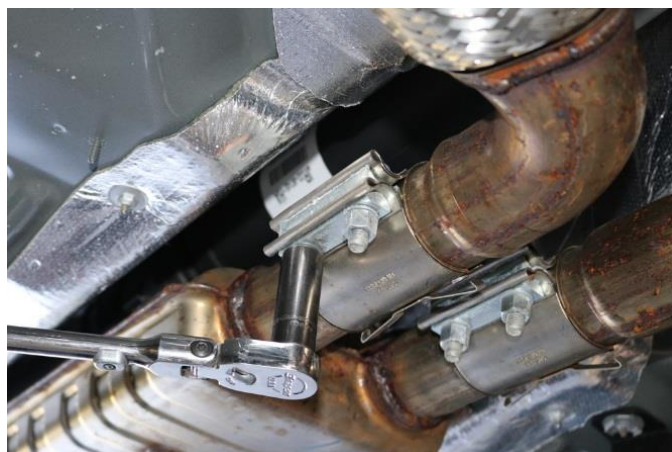

- 8.** Use a 3/8" drive ratchet and 15mm deep socket to loosen both nuts on each of the two sleeve clamps as shown.

NOTE: Both nuts must be loosened for the sleeve clamps to fully disengage.

Continued on Next Page ...

REMOVAL INSTRUCTIONS

FACTORY EXHAUST



- 9.** Use a 3/8" drive ratchet and 13mm socket to remove the bolt holding the driver side hanger grommet assembly. Push up slightly on the exhaust and slide the hanger grommet assembly rearward to free it from the rear suspension sub-frame. Rotate the hanger grommet assembly a minimum of 90° so it will not interfere with the rear suspension sub-frame. Repeat for passenger side. **Set aside the fasteners in a protected location to be reused in INSTALL STEP 8.**



- 10.** Slide the stock exhaust assembly rearward until the stock resonator and sleeve clamps are free from the exhaust manifold pipes. Lower the front of the exhaust then slide it forwards to remove the rear driver and passenger side hangers from their hanger grommets and remove the exhaust from the vehicle. **NOTE:** The use of a soap and water solution may aid in the removal of hangers from the grommets.
- 11.** Place a piece of tape on each exhaust valve actuator and label them "D" for driver and "P" for passenger side.

Continued on Next Page ...

REMOVAL INSTRUCTIONS

FACTORY EXHAUST



- 12.** Use a 3/8" drive ratchet and a 10mm socket to remove the three nuts on each actuator. Remove the actuators from their valve assemblies. Place the actuators in a safe location to be used during **INSTALL STEP 16**. Install the hardware and anchor brackets back onto the studs or store in a safe location since they will **NOT** be re-used during installation.



- 13.** Remove the driver and passenger side hanger grommet assemblies from the axle pipe hangers using grommet pullers or a similar device. Save for **INSTALL STEP 5**.

NOTE: Both hanger grommets are oriented as shown on the stock exhaust, the grommets will need to be reinstalled in the same direction for the CORSA exhaust system.

Step 13 concludes the removal of the factory exhaust.

WARNING! DO NOT SKIP THIS STEP!

It is recommended to apply anti-seize lubricant to the threads **ONLY** of all the clamps and flange bolts. Failure to follow this procedure can cause nuts to seize on clamps and potentially destroy threads.

After applying anti-seize lubricant, be sure to **thoroughly** clean your hands, as lubricant will tarnish stainless steel.

All clamps should be tightened using a properly calibrated Torque Wrench. Using an air impact gun will damage the clamp and reduce its ability to effectively seal the joint. It may also cause the joint to separate, thereby causing damage to your exhaust system and to your vehicle.

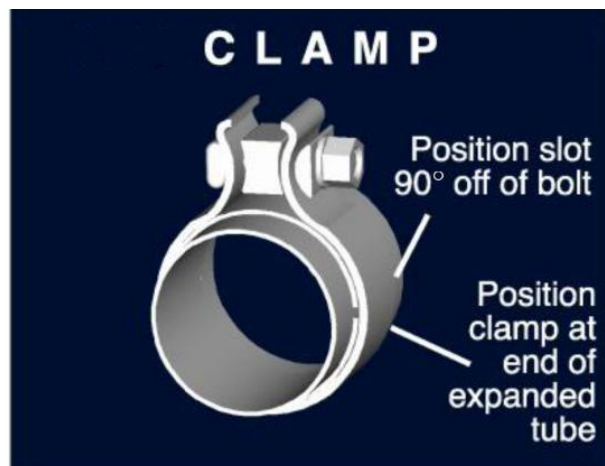

NOTE: Align all clamps so that the center of the clamp bolt is 90 degrees from the notch in the pipe.

INSTALLATION INSTRUCTIONS

CORSA EXHAUST



1. Locate the two X-Pipe inlet adapters. Slide the adapters into the factory sleeve clamps, and tighten using the ratchet and 15mm deep socket, until the adapters are snug in the clamps.



2. Install two 3" clamps on the driver and passenger inlets of the Double X-Pipe so that the bolts are vertical with the nut towards the ground and the bolts towards the outside of the vehicle.



3. Slide the X-Pipe inlets over the X-Pipe adapter outlets.

4. Position the X-Pipe so the cross brace located at the rear of the X-Pipe is facing down and parallel with the ground, and the outlets are centered around the differential. Tighten the clamps using a ratchet and 15mm deep socket, until the X-Pipe is snug on the adapters. Place a jack stand or similar device under the X-Pipe for support.



Continued on Next Page ...

INSTALLATION INSTRUCTIONS

CORSA EXHAUST



5. Locate the passenger side axle pipe assembly, and the hanger grommet assembly removed during **REMOVAL STEP 13** of the stock exhaust removal process. Install the hanger grommet assembly onto the front hanger of the muffler assembly in the same position as previously installed on the stock exhaust.

NOTE: The use of a soap and water solution may aid in the installation of hanger grommets



6. Locate one 3" clamp. Install the clamp on the passenger side muffler inlet pipe so that the bolt is vertical with the nut towards the ground and the bolt is towards the inside of the vehicle.



7. Slide the axle pipe inlet pipe over the passenger side X-pipe outlet. **NOTE:** The use of a soap and water solution may aid in the installation of hanger grommets.

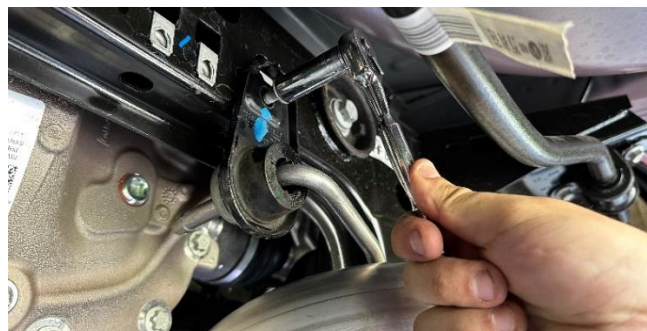

8. Locate a 13mm bolt set aside during **REMOVAL STEP 9** of the stock exhaust removal process. Install the front passenger hanger grommet assembly onto the rear suspension sub-frame and tighten it down with the 13mm bolt, 3/8" ratchet and 13mm socket.



9. Tighten the clamp connecting the passenger axle pipe to the passenger side X-pipe outlet using the 3/8" ratchet and 15mm deep socket until the axle pipe assembly is snug on the X-pipe.

Repeat **INSTALL STEPS 5-9** on the driver side of the vehicle.

Once the system is secure, it is safe to remove the jack stand from beneath the X-Pipe

Continued on Next Page ...

INSTALLATION INSTRUCTIONS

CORSA EXHAUST



- 10.** Locate the passenger side muffler assembly and one 3" clamp. Install the clamp on the muffler inlet pipe so that the bolt is vertical with the nut towards the ground and the bolt is towards the muffler case (facing the rear of the vehicle).

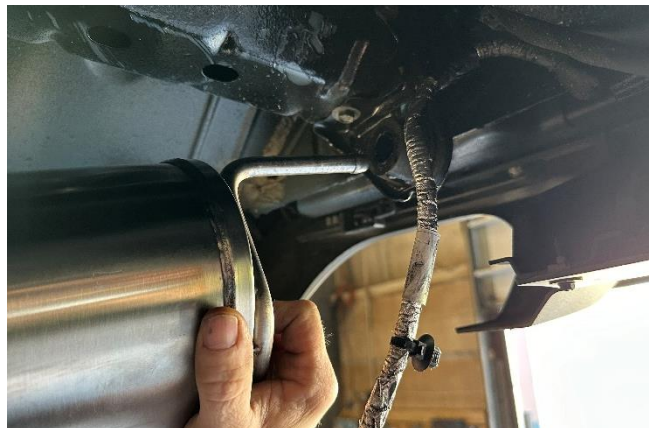

- 11.** Slide the rear hanger into the rear hanger grommet located on the vehicle above and just inside of the passenger side tip cut out.

NOTE: The use of a soap and water solution may aid in the installation of hanger grommets.



- 12.** Slide the muffler inlet pipe over the passenger side axle pipe outlet. Tighten the clamp using the 3/8" ratchet and 15mm deep socket until the muffler assembly is snug on the axle pipe.

Repeat **INSTALL STEPS 10-12** on the driver side of the vehicle.

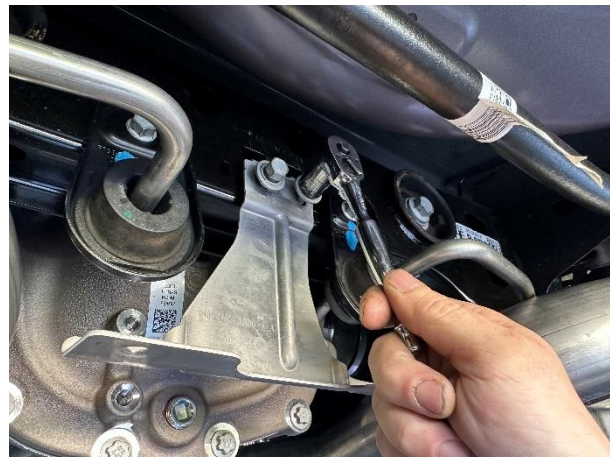

- 13.** Locate the rear under tray mounting bracket and the two bolts set aside in **REMOVAL STEP 4** of the stock exhaust removal process. Install the rear under tray mounting bracket onto the rear suspension sub-frame and tighten it down with the two bolts using a 3/8" ratchet and 13mm socket.

Continued on Next Page ...

INSTALLATION INSTRUCTIONS

CORSA EXHAUST

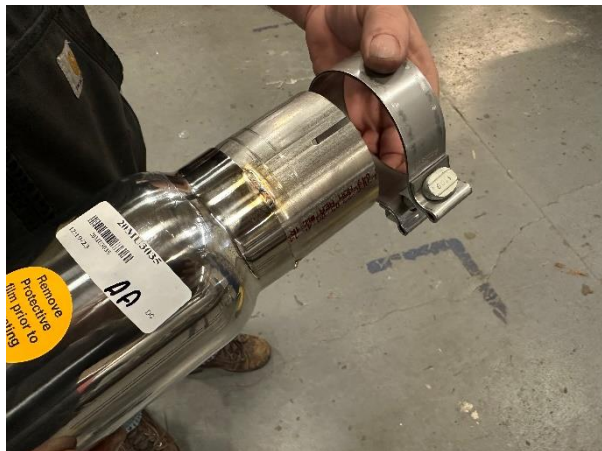

- 14.** Locate one of the passenger non-valved tip assemblies and one 3" clamp. Install the clamp on the tip inlet pipe so that the bolt is vertical with the nut towards the ground and the bolt towards the outside of the vehicle.



- 15.** Slide the tip assembly over the muffler outlet pipe and tighten the clamp using the ratchet and 15mm deep socket until the tip assembly is snug on the muffler outlet pipe. Repeat for the driver side tip assembly.



- 16.** Confirm the spring wire form is correctly positioned on the passenger side stock valve actuator from **REMOVAL STEP 12**. Position and install passenger valve actuator onto the CORSA passenger valved tip assembly. Confirm that the spring wire form is located within the grooves of the valve assembly.

NOTE: The passenger valved tip assembly can be distinguished from the driver side by the rotation of the valve relative to the CORSA etch. Hold the tip assemblies with the etch position directly on top. The valve will be rotated towards the right for the passenger side tip assembly and towards the left for the driver side when viewed from the outlet end. Both slash cut and straight cut options are shown for reference.

Continued on Next Page . . .

INSTALLATION INSTRUCTIONS

CORSA EXHAUST



- 17.** Line up the holes on the passenger actuator to the threaded spacers on the valve assembly.
NOTE: There will be some resistance from the spring wire form as you rotate the actuator into position. This is normal, as the valve plate is designed to apply pressure to the valve body when in the closed position and will help in preventing rattles.

Use a 10mm socket and 3/8" drive ratchet to secure the valve actuator with the three provided M6 bolts with a blue Loctite patches. Repeat **INSTALL STEPS 16-17** for the driver side valved tip assembly.

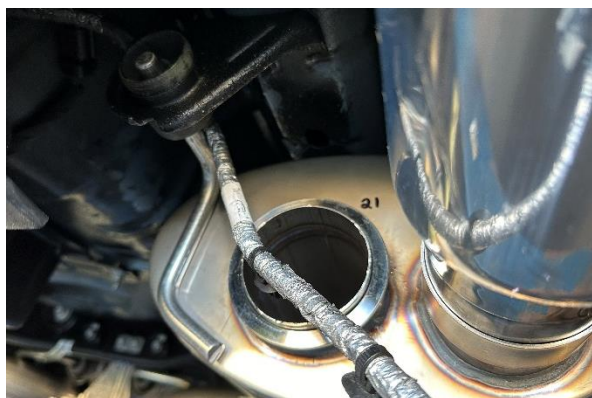

- 18.** Reposition the driver and passenger valve actuator harnesses over their corresponding muffler hangers.



- 19.** Connect the passenger side harness into the actuator mounted to the passenger valved tip assembly by pushing the plug until you hear a click, followed by the white locking clip. Once the actuator is secure, remove the "P" label from the actuator.



- 20.** Mate the v-band flange on the driver valve tip assembly to the flange on the muffler. Align and position the v-band flange so both flanges are fitted within the grooves of the clamp. Reinstall the lock nut and snug the clamp using an 11mm deep socket and 3/8" drive ratchet. The clamp should be positioned with the lock nut towards the inside of the vehicle, the bolt on top and horizontal.



Continued on Next Page . . .

INSTALLATION INSTRUCTIONS

CORSA EXHAUST



- 21.** Repeat **INSTALL STEPS 19-20** for the driver side valved tip assembly.

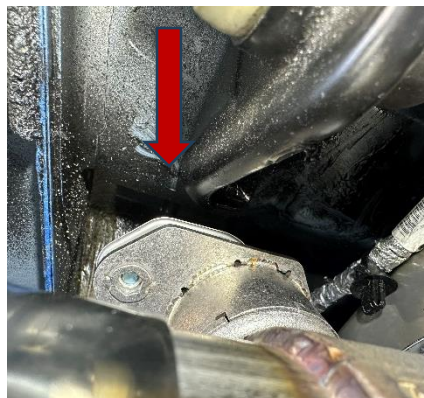

- 22.** Adjust the system, including the adapter overlap on the stock exhaust, the axle pipe depth and rotation, the rear muffler depth and rotation, and the tip depth and rotation, so that the tips are centered in the bumper valence. Rotate the tips so that the CORSA etch is on top. Check the position of all hangers to make sure they are properly seated within their corresponding grommets. Check clearances between the system components and chassis, especially the valve to chassis clearances. At this time, tighten the v-band clamp to 10ft-lbs and all other clamps to 45ft-lbs using the torque wrench and 15mm socket. Start the vehicle and cycle the exhaust modes from Quiet to Track to verify proper valve function.
- 23.** Locate the rear under tray and all fasteners set aside in **REMOVAL STEP 3** of the stock exhaust removal process. Reinstall the rear under tray. Installation is reverse of removal. Refer to **REMOVAL STEPS 1-3**. Installation complete. This concludes the installation of your CORSA Performance exhaust system.

NOTE: During cold weather start-ups, you may experience an exhaust sound that is deeper and louder in tone than usual. This is temporary and will diminish to normal levels once your engine has reached its normal operating temperature.

NOTE: Immediately following the installation of your exhaust system, you may experience a trace of smoke after initial start-up. DO NOT be alarmed. The smoke is caused by the burning of a small amount of forming oil residue used in the manufacturing process.

NOTE: It is strongly suggested that all clamps be checked and tightened after road testing the vehicle once the system has cooled.