

2015-2017 5.0L Mustang Phase 2 ROUSHcharger Kit Installation Instructions P/N: 422001 (R1315-P2CAL)



Application:

**2015-2017 Ford Mustang GT with 5.0L 4-Valve Engine
EO D-418-29 2015-2016 Mustang only**

Important Notes:

- Before installing your Mustang ROUSHcharger Kit, please read the installation manual and verify that all items are present. If you are missing hardware or have any questions, please contact ROUSH Performance at 1-(800) 59-ROUSH.
- Premium fuel (91 octane or higher) is required to prevent “spark-knock” or detonation under certain operating conditions.
- The use of fuel additives (i.e. octane boosters) is not recommended. There is a possibility that these chemicals can damage your engine and cause drivability issues with your vehicle.
- Operating your engine without the ROUSH PCM recalibration will result in engine damage or failure and will void your warranty.
- Not recommended for vehicles equipped with adaptive cruise control option.
- This system is not eligible for the ROUSH extended powertrain warranty.

Table of Contents

Packing List for 422001 (R1315-P2CAL) ROUSHcharger Kit 3

Equipment and Supplies Required..... 6

Glossary of Terms..... 6

Information About the Supercharger Bypass Operation 7

Limit of Liability Statement..... 7

Safety Precautions 7

Section A – Disassembly..... 8

Instructions for Returning The PCM to ROUSH for Calibration 10

Section B – Modifications..... 28

Brake Booster Vacuum and Aspirator Hose Assembly Modification 28

Evaporative Emissions Canister Purge Line..... 30

K-Brace Modification 31

Electric Fan Shroud Modification 31

Front Cover Modification..... 32

Intake Valley Modification..... 33

TPS/ETC Wiring..... 34

Evaporative Emissions Canister Purge Valve Wiring..... 37

Air Charge Temperature (ACT) Wiring 38

TPS/ETC and EECPV Harness Routing 38

Engine Harness Ground Wire..... 40

Intercooler Pump Wiring..... 41

Knock Sensor Orientation Adjustment..... 45

Changing the Factory Spark Plugs 46

Section C – Subassembly 50

Intercooler Low Temperature Radiator (LTR)..... 50

Intake Manifold Buildup 50

Supercharger Buildup..... 50

Fuel Rail Assembly 51

Airbox Assembly 52

Section D – Installation 55

Induction Resonance Tube Delete Grommet 55

Intake Manifold, Fuel Rails, Supercharger, Spacer and Throttle Body..... 55

FEAD Assembly..... 65

Intercooler Low Temperature Radiator (LTR) Assembly 69

Intercooler Pump, Mounting Bracket and Hoses 71

Electric Fan, Intercooler Reservoir and Hoses 74

Radiator Hoses, Engine Degas Bottle and Hoses..... 76

Air Induction System 77

K-Brace 79

Section E – Final Assembly..... 80

PCM Flashing..... 81

PACKING LIST FOR 422001 (R1315-P2CAL) ROUSHCHARGER KIT

Description	Part Number	Quantity
Air Induction		
Upper Airbox Cover/Lid	1315-9643	1
MAF Tube Assembly	1315-12B579HC	1
Lower Airbox Tray	1315-9A612	1
Dirty Air Duct	1315-9F763	1
Tube Assembly, Clean Air w/fittings	1315-9R504	1
Filter w/ Clamp - Red (dry)	1315-9601R	1
Hardware Kit A – Air Induction	1315-TVSHKA	1
Hose Clamp	R07130015-13	2
Screw, Self-Tapping M6 x 25 mm	W506976	6
Bolt - MAF Tube to Airbox (M8 x 1.25 x 25)	W500224	2
J-Clip - MAF Tube to Airbox (M8)	W520823	2
Grommet - Boom Tube Delete	W651016	1
Intake Manifold Hardware		
Manf Assembly - Fuel Charging	1315-9H487	1
Supercharger Assembly - less pulley	1315-6F066	1
Badge - Supercharger (ROUSH / FRT)	1315-6F066BDG	1
Pulley - 6K Grooved - 80 mm	1313-6K80	1
Fastener - Pulley to Supercharger (M6 x 1.0 x 16)	W500013	6
Fuel Injector Kit	13119F593K	1
Fuel Rail Assembly	1315-19F792	1
Clip - Fuel Injector	13119C995	8
T-Body Spacer	1315-9P697	1
T-Body Assembly (dual 60mm)	R07060150-13	1
Spark Plug - 0.9 mm gap	M-12405-M50	8
Hardware Kit B - Fuel Charging Assembly	1315-TVSHKB	1
Gasket - Spacer to Supercharger (Viton 5.109" dia)	1315-9E152	1
Gasket - T-Body to Spacer	R07060153-13	1
Screw and Washer - T-Body and Supercharger to Spacer (M6 x 1.0 x 32.5)	R18020009-00	8
Bolt - Intake to Cylinder Head (M6 x 1 x 40)	R18020004-00	6
Bolt - Supercharger to Intake Manifold Upper (M8 x 1.25 x 53)	N808130	10
Screw and Washer - EECPV to Supercharger (M6 x 1.0 x 35.5)	N808429	2
FEAD		
FEAD Bracket - Upper	1314-8B653U	1
FEAD Tensioner Bracket Assembly	13118B603	1
Serpentine FEAD Belt - 1st Sheave 6K	K060806	1
Hardware Kit C - FEAD	1315-TVSHKC	1
Pulley - Idler B/S 76 mm (Double Flanged)	953045	2
Bolt - Idler (M8 x 1.25 x 28 large washer)	R18020060	2
Bolt - Upper Bracket to Engine and Upper Intake (M8 x 1.25 x 84)	W704752	2
Bolt - Upper Bracket to Engine (M8 x 1.25 x 60)	11116346	3

Description	Part Number	Quantity
Bolt - Lower Bracket to Upper Bracket (M8 x 1.25 x 41)	W705128	1
Bolt - Lower Bracket to Engine (M8 x 1.25 x 120)	N811329	2
PCV and Vacuum		
PCV Fresh Air Inlet	1315-6758	1
PCV Purge Hose w/Bubbler - Valve to Spacer	13116K817	1
Hardware Kit D - PCV and Vacuum	1315-TVSHKD	1
Vacuum Hose - Supercharger Bypass (0.6 FT)	1315-9E498	1
Clamps - 5/8" Hoses (Constant Tension)	7329K11	2
Hose - Aspirator to Booster	1315-9D690	1
Hose - Aspirator to Clean Air Tube	1315-9D691	1
Hose - Aspirator to SC	1315-9D692	1
Brake Aspirator Plug	CS2575	1
Protective Hose Sleeve for EECPV (Length=975 mm/38.5") (pre-cut)	1150-18K579SLV	1
Protective Hose Sleeve for Heater Hose (Length 424 mm)	1311-18K579	1
Vacuum Harness - Supercharger Bypass Reference	7R3V-9E498	1
Wiring		
Hardware Kit E - Wiring	1315-TVSHKE	1
Electrical Jumper - I/C Pump	1315-8W501	1
ACT Wiring Harness	1315-12A690	1
TPS/ETC Extension Harness	131114A595	1
Intercooler Pump Adapter harness	PT00045528	1
EECPV Extension Harness	13119G866	1
Connector - Block Off IMRAC	1315-14A464	1
Zip tie w/Fur Tree (Wire Harness retention to Front Cover)	156-00329	1
Nut - I/C Relay Mounting (M6 x 1.0)	W520412	2
Bolt - I/C Relay Mounting (M6 x 1.0 x 14)	N605771	1
Fuel Pump Voltage Regulator	1315-FPVRKIT	1
Decals/Labels/Instructions		
Hardware Kit F - Decals	1315-TVSHKF	1
Decal - Premium Fuel Only (Fuel Door)	13109A095	1
Decal - 2011 Belt Routing and Vacuum	13116E072	1
Decal - PCM	R07100008-10	1
Label - Spark Plug Warning	PT00045644	2
Intercooler System - Tubes, Hoses and Clamps		
3/4" Hose Assembly - Intrclr Resvr Inlet	1315-8D031	1
3/4" Hose Assembly - Intrclr Pmp Inlet	1315-8D029	1
3/4" Hose Assembly - Intrclr Pmp to LTR	1315-8K236	1
3/4" Hose Assembly - Intrclr LTR Outlet	1315-8D030	1
3/8" Hose Assembly - Engine Bottle Degas Hose	1315-8276	1
Heater Hose Assembly	1315-18K579	1
Hardware Kit G - Clamps	1315-TVSHKG	1

Description	Part Number	Quantity
Clamps - 3/4" Hoses (Constant Tension)	CT19x12-BO	9
Intercooler System - Miscellaneous		
Degas Bottle	1315-8D080	1
Degas Bottle Mounting Template	1315-DGSTMPL	1
I/C Electric Water Pump	FS00057975	1
Low Temperature Radiator Assembly	1315-8K229	1
Band Clamp (5/8"-1/4" x 5/16")	62002	1
Hardware Kit H - Intercooler System	1315-TVSHKH	1
Degas Bottle Cap	9C3Z-8101	1
I/C Pump Bracket	1318-8C4191	1
I/C Bracket retainer	1318-8C4192	2
Bracket - LTR Lower RH	1315-8K245	1
FOAM - Water Pump / Reservoir Mounting	1318-8D082-AA	5
P-Clip	886T95	1
Bracket - LTR Lower LH	1315-8K244	1
Rubber Grommet - LTR Isolator	R07060107-13	2
Sleeve - LTR Isolator	R07060108-13	2
Bolt- IC Pump Bracket to Chassis/LTR (M8 x 1.25 x 16)	BCSM08016S	1
Bolt - Degas bottle to Fan shroud and I/C Pump Brkt (M6 x 1.00 x 16)	N605891	2
Nut - LTR to Rad Support (M8)	W520413	4
Bolt - LTR Bracket to Chassis (N804394-S439)	W705128	6
J-Clip - (M8 Short)	W520823	2
Degas Bottle to Fan Shroud Retaining Clip	20860	1
J-Clip - Degas Bottle (M6 Short)	N623332	2
Flange Bolt (M8 x 1.25 x 16 mm)	161821	6
Paperwork		
RDT Voucher Card - 2015 Mustang Retail Phase 2	P1315-P2CAL	1
Decal - Premium Fuel (Cluster)	R0711004-11	1
Instructions and Calibration Information	1315-P1INST	1
EO Label	D41829-9A095EO	1

If you are missing any items, please call us toll free at 1-800-59-ROUSH.

EQUIPMENT And SUPPLIES REQUIRED

- 1/4" and 3/8" Drive Ratchets with Extensions
- Metric and Standard Socket Sets (short and deep recommended)
- Metric and Standard Wrench Sets
- 3/8" Drive Torque Wrench (7-35 ft-lb range)
- 6" Scale, Tape Measure, or Other Measuring Device
- Assembly Lubricant (White Lithium Grease or Petroleum Jelly)
- Electrical Tape
- Sharp Knife or Razor Blade
- Medium Strength Thread Locker – Loctite® 242 (blue) or equivalent
- T-20 Torx Bit Screwdriver or Socket
- 5/16" Drill Bits and Drill motor
- Coolant (meeting Factory Ford specification for 2015 Mustang GT)
- 1/2" Drive Ratchet or Breaker Bar
- Short Phillips-head Screwdriver
- 5/8" Fuel Line Removal Tool
- Solder and Soldering Iron
- Heat Gun or Small Torch for Heat Shrink Tubing
- Tie Straps (Zip Ties)
- Trim Pad Tool (for pushpin removal)
- Fender Cover (2)

GLOSSARY OF TERMS

Air Charge Temperature (ACT) Sensor (From the factory, this function is integrated into the MAF sensor. With this kit, a separate ACT sensor is installed into the intake manifold)

Electronic Throttle Control (ETC)

Mass Air Flow (MAF) Sensor

Powertrain Control Module (a.k.a. ECM, ECU, PCU, EEC)

Positive Crankcase Ventilation (PCV)

Throttle Position Sensor (TPS)

ROUSH Diagnostic Tool (RDT)

Vapor Management Valve, or Evaporative Emissions Canister Purge Valve (EECPV)

Breakout Point – A place in an electrical harness where the wiring for an individual component leaves (breaks out of) the main harness to attach to an individual component.

INFORMATION ABOUT THE SUPERCHARGER BYPASS OPERATION

There is a great deal of misinformation about the function of supercharger bypass systems. The supercharger is a positive-displacement pump; that is, so long as it is rotating, it is always pumping air. During low demand or high vacuum operation (i.e. idle, deceleration, and light throttle cruise), the pumping action is undesirable as it creates unwanted heat and noise. The bypass circuit, when open, prevents any pressure buildup across the supercharger and allows air to circulate through the rotors, allowing the supercharger to “idle” freely during these conditions. This results in reduced noise, and by reducing heat buildup in the intake, significantly improves street and strip performance. As throttle demand increases, the bypass circuit is closed, resulting in full performance from the supercharger. The bypass circuit is never used to limit or control boost during full-throttle operation and defeating or altering the bypass function will not result in improved performance in any condition, and will result in poor drivability.

LIMIT OF LIABILITY STATEMENT

The information contained in this publication was accurate and in effect at the time the publication was approved for printing and is subject to change without notice or liability. ROUSH Performance Products reserves the right to revise the information presented herein or to discontinue the production of parts described at any time.

SAFETY PRECAUTIONS



CAREFULLY READ THE IMPORTANT SAFETY PRECAUTIONS and WARNINGS BEFORE PROCEEDING WITH THE INSTALLATION!

Appropriate disassembly, assembly methods and procedures are essential to ensure the personal safety of the individual performing the kit installation. Improper installation due to the failure to correctly follow these instructions could cause personal injury or death. Read each step of the installation manual carefully before starting the installation.

- Always wear safety glasses for eye protection.
- Place the ignition switch in the OFF position.
- Always apply the parking brake when working on the vehicle.
- Block the front and rear tire surfaces to prevent unexpected vehicle movement.
- Operate the engine only in well-ventilated areas to avoid exposure to carbon monoxide.
- Do not smoke or use flammable items near or around the fuel system.
- Use chemicals and cleaners only in well-ventilated areas.
- Batteries can produce explosive hydrogen gas which can cause personal injury. Do not allow flames, sparks or flammable sources to come near the battery.
- Keep hands and any other objects away from the radiator fan blades.
- Keep yourself and your clothing away from moving parts when the engine is running.
- Do not wear loose clothing or jewelry that can be caught in rotating or moving parts.

SECTION A - DISASSEMBLY

The following section will guide you through the disassembly of the stock components. Special care should be taken to label fasteners and parts that are taken off during this procedure since many will be reused:

1. Cover both fenders with fender covers to protect the vehicle finish.
2. Release the fuel system pressure.

NOTE: The following procedure is taken directly from the Ford Service Manual.

WARNING

Fuel in the fuel system remains under high pressure even when the engine is not running. Before working on or disconnecting any of the fuel lines or fuel system components, the fuel system pressure must be relieved. Failure to do so can result in personal injury.

WARNING

Do not smoke or carry lighted tobacco or open flame of any type when working on or near any fuel-related components. Highly flammable mixtures are always present and can be ignited, resulting in personal injury.

- a. Open the vehicle doors and lift the bottom cushion of the back seat. It is held in place by a push tab in the center of each cushion.



- b. Disconnect the fuel pump control module electrical connector located under the driver side back seat.



- c. Start the engine and allow it to idle until it stalls.
 - d. After the engine stalls, crank the engine for approximately 10 seconds to make sure the fuel injector supply manifold pressure has been released.
 - e. Turn the ignition switch to the OFF position.
3. Open the hood. Remove the push pins from the battery cover panel located on the passenger side of the engine bay, and remove the panel.



4. Loosen the retaining nuts and disconnect the (-) negative and (+) positive connections to the battery. Stow the cables out of the way.



5. Release the (8) push pin retainers by pulling the center pin and remove the radiator trim cover.

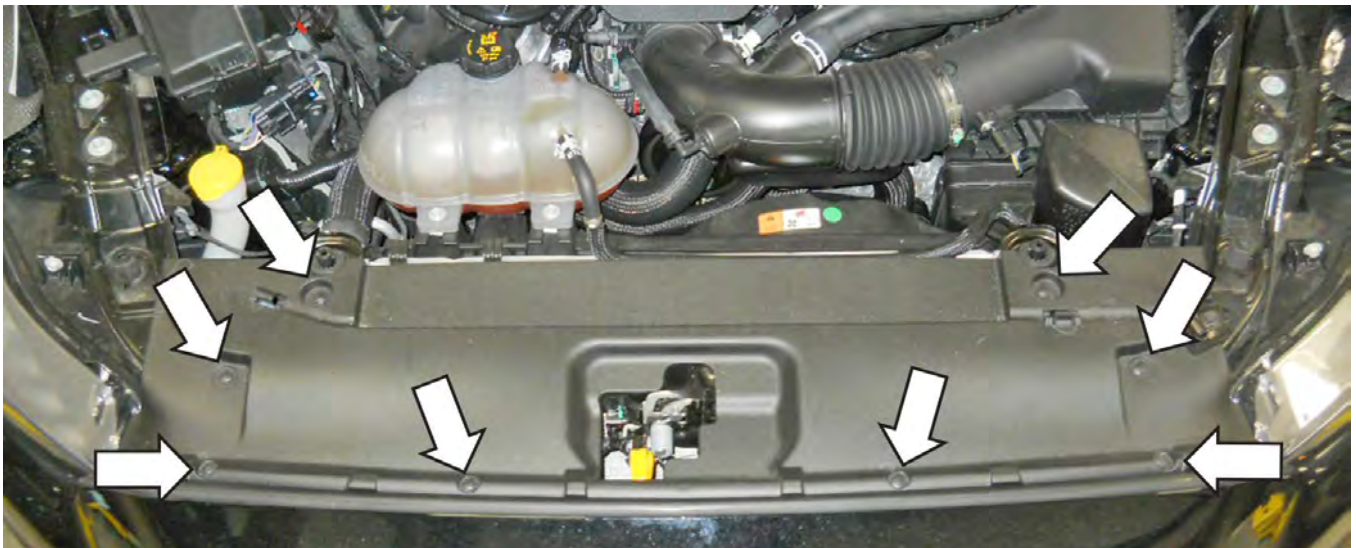

Before continuing, refer to the CALKIT found on our website under product ID 421823. Determine the PCM flash method you will be using. If performing the PCM flash yourself or at a preferred ROUSH dealer, proceed to step 9. If sending the PCM to ROUSH for a ROUSH performed PCM flash, continue with step 6.

6. Depress the tabs on the fuse box and lift it up to access the PCM underneath.



7. Disconnect the two (2) PCM (Powertrain Control Module) connectors by lifting the grey levers over the connector back shell and lifting the connectors from their sockets.



8. Remove the PCM by removing two (2) 10 mm bolts and pulling the PCM forward and lifting out of the engine compartment. Follow the instructions on the next page as soon as possible to help minimize the amount of time you are without a PCM.

IMPORTANT: Be sure to write your VIN number and phone number (in case we need to contact you for additional vehicle information) on the PCM using a permanent marker.

INSTRUCTIONS FOR RETURNING THE PCM TO ROUSH FOR CALIBRATION

Outlined below are the instructions for returning your stock powertrain control module (PCM) to ROUSH Performance Products so we can install our calibration to make the engine run properly with the new components. **Please complete the "Base Limited Warranty Registration" card and include it, along with the PCM, the "Optional ROUSH PCM Flash" request document, and the "Voucher Card".** Once we receive your PCM, we will reprogram and return it back to you the same day for next-day delivery. Operating your engine without our calibration will result in engine damage or failure and will void all warranty.

NOTE: It is important to reinstall the PCM in the vehicle it came from to prevent setting a trouble code and having to relearn the anti-theft code which can only be performed using specialized Ford Service Bay tools.

- If you haven't already done so, write your vehicle identification number (VIN) and phone number on the PCM using a permanent marker.
- Using bubble wrap, or another appropriate packing material, wrap and package the PCM to help prevent it from being damaged during shipping.
- Place the wrapped PCM in an appropriate shipping box.
- **Complete the "WARRANTY REGISTRATION CARD" (1315-P1TVSCAL),**
- **Complete the "Optional ROUSH PCM Flash" request document (PCM-FLASHDOC) and attach the flash "VOUCHER CARD" (P1315-P1) to the document.**
- **Include the "Warranty Registration Card", "Optional ROUSH PCM Flash" document, and the "Voucher Card" in the shipping box, along with the PCM.**

- Ship the PCM and contents to:

CALL FOR MORE INFO

800-597-6874

Upon receipt of the PCM, a customer service representative will contact you to arrange payment. Once you receive your ROUSH flashed PCM, reverse step 8 for PCM installation.

If flashing the vehicle using RDT, proceed with step 9.

9. Raise the front of the vehicle using the Ford recommended lifting points and place onto safety stands. With the tires lifted off of the ground, remove the front wheels.



10. Note the position of the fourteen (14) small, medium and large pushpins on the inner wheel well splash shields so they can be reinstalled in the same position. Remove the pushpins then remove the inner wheel well splash shields.



11. Remove the nineteen (19) lower close-out panel bolts and the two (2) pushpins. Remove the lower close-out panel from the vehicle (7 mm socket).



12. With the engine cool, remove the cap on the engine coolant degas bottle and drain the coolant using the petcock located on the lower passenger side of the radiator. Save the coolant for reuse.

Tip: Connect a 3/8" hose to the drain fitting next to the petcock and run into a clean drain pan or bottle. Use a 3/4" wrench to open petcock and allow coolant to drain out of the fitting.



13. If equipped, remove the four (4) nuts and the strut tower cross brace (15 mm socket). The strut tower cross brace cannot be reused after the supercharger has been installed. Discard the nuts.



14. Lift up and remove the engine appearance cover. The cover cannot be reused after the supercharger has been installed.



15. Mark a cut line on the LH side of the K-brace using the wiper cowl as a guide as shown. Remove the six (6) pushpin retainers on the cowl trim panel. Lift up the cowl trim panel and remove the two (2) nuts and five (5) bolts from the K-brace. Slide the K-brace out from the cowl trim panel and remove it from the vehicle.



16. Pry up the pushpin securing the induction resonance tube to the strut tower. Remove the mounting nut at the base of the induction resonance tube at the firewall (10 mm). If necessary, remove the dipstick to gain access to the nut. Remove the induction resonance tube from the cowl. The induction resonance tube will not be reused.



Showing nut at firewall

17. Disconnect the brake aspirator line from the clean air tube.



18. Disconnect the vacuum line from the air cleaner tube.



19. Disconnect the positive crankcase ventilation (PCV) tube from the clean air tube.



21. Loosen the clamps securing the clean air tube at the airbox and throttle body. Remove the clean air tube from the throttle body and airbox lid. The clean air tube will not be reused.



Clamp at air box

20. Disconnect the PCV fresh air inlet tube from the left-hand cam cover and remove the tube from the vehicle.



Clamp at throttle body

22. Remove the MAF (mass air flow) sensor connector by pulling the red locking tab back and pressing the black release tab. Release the two (2) locking tabs securing the upper airbox lid to the lower airbox. Disconnect the MAF wiring harness retainer from the front edge of the upper airbox lid. Remove the lid from the vehicle and set it aside. The MAF sensor will be reused and the airbox lid will be discarded.



23. Remove the filter from the airbox. Remove the mounting bolt at the side of the airbox (10 mm socket). Pull up and remove the lower airbox from the vehicle.





24. Disconnect the brake aspirator.

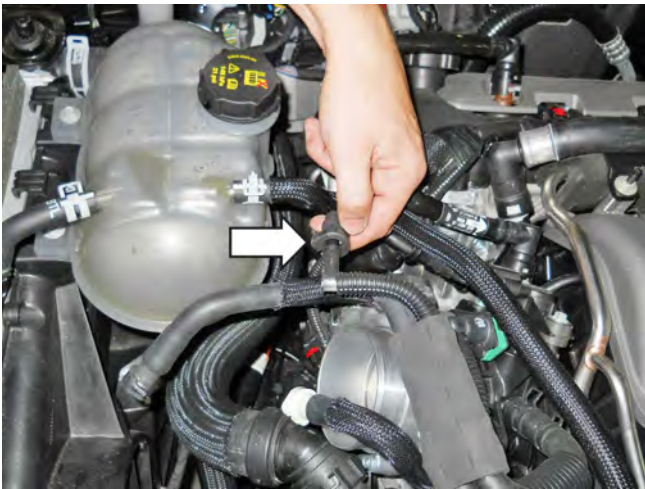

25. Disconnect the throttle body electrical connector. Pull the red locking tab back; press the black release tab to disengage the lock.



26. Unlock the green connector and disconnect the evaporative emission canister purge valve (EECPV) tube and electrical connector (green). Remove the EECPV tube retainer from the front left hand cam cover. Disconnect the remainder of the tube at the fitting located behind the inner fender (pry from retainer) below the brake booster. Remove from vehicle and set it aside. The quick connect (green locking) connectors must be transferred to the new line in Hardware Kit E.



EECPV electrical connector



EECPV tube quick connector with green lock

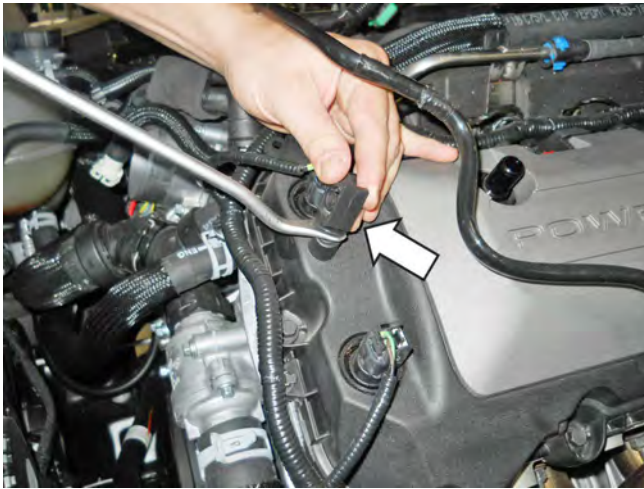

Remove retainer on cam cover



27. Remove the PCV purge line from the intake manifold and RH cam cover. This line will not be reused.



Remove tube from retainer



28. Disconnect the fuel supply hose from the fuel rail.
NOTE: Use a rag to catch any excess fuel during disconnection. Use a cap, tape or other suitable method to block the rail opening from contaminants.



Disconnect green quick connect fitting



29. Disconnect the brake booster vacuum hose from the intake manifold. This port is located directly behind the throttle body.



32. Disconnect the brake boost vacuum hose from the port at the firewall.



30. Move the LH heater hose aside from the support bracket on top of the LH cylinder head.

31. Remove the two (2) nuts that secure the brake boost vacuum hose and heater hose support bracket to the LH cylinder head.



33. Remove the brake boost vacuum hose/line from the vehicle and set it aside. This line will be modified.

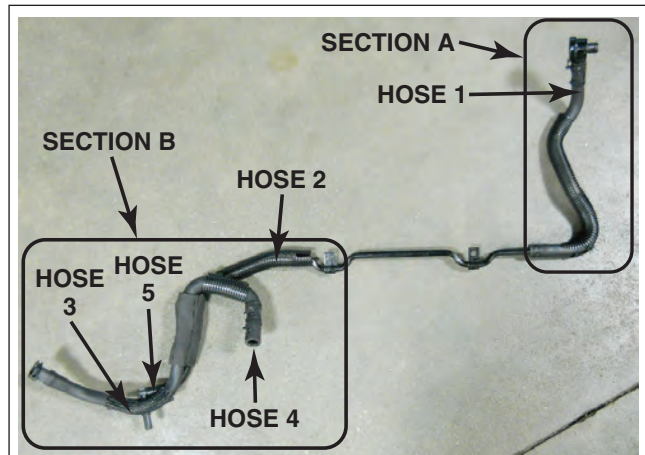

34. Remove the LH heater hose support bracket and fuel rail cover from the LH side of the cylinder head.



LH

35. Remove the two (2) nuts and support bracket that retained the RH heater hose above the RH fuel rail. This hardware will not be reused. Remove the support bracket and fuel rail cover from the RH cylinder head.

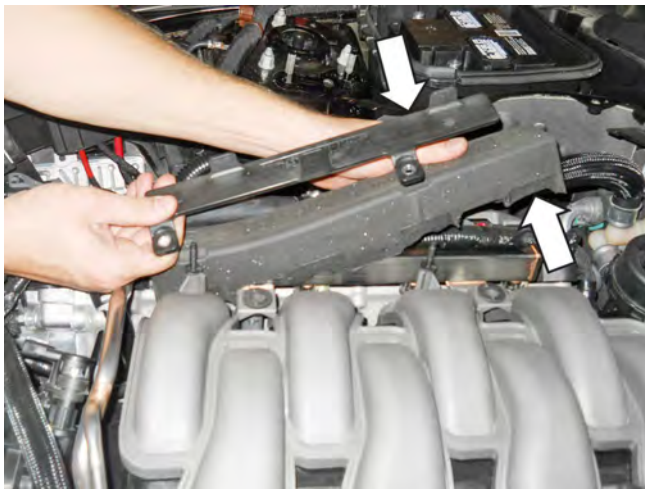

36. Disconnect the heater feed and return hoses located at the front of both the LH and RH cylinder head intake flanges. Disconnect and remove the hoses from the ports on the RH firewall.



37. Disconnect the clamps on the hose ends and remove the 3/8" engine coolant degas hose from both the engine and the degas bottle.

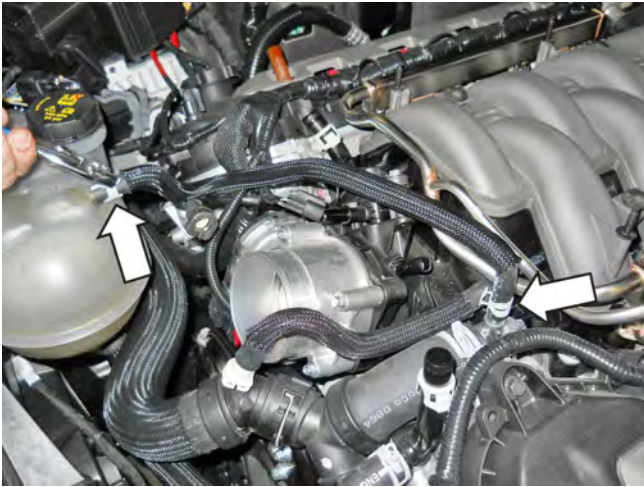

38. Remove the four (4) fuel rail bolts. These bolts will be reused.

NOTE: It is not necessary to remove the fuel rail from the intake manifold assembly.



LH



RH

39. Disconnect the eight (8) fuel injector electrical connectors (four [4] on each side).

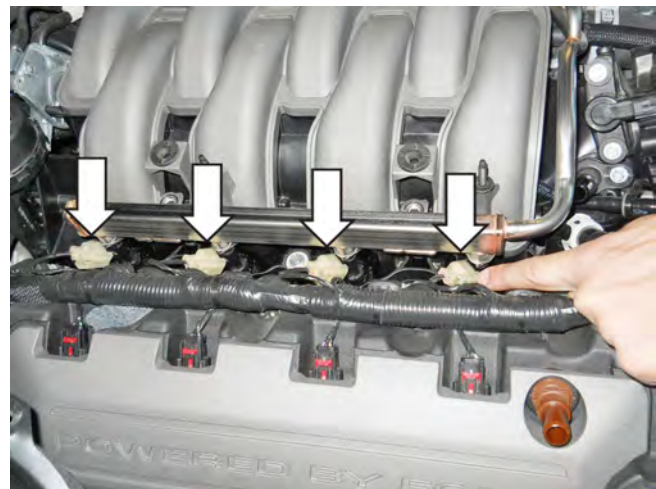

RH shown

40. Remove the line from retainer near the front of the RH cylinder head.



41. Remove the six (6) intake manifold mounting bolts.
42. Lift the intake manifold and fuel rail assembly straight up and pull it forward to access the harness connectors at the rear. Disconnect the CMCV harness connector. Cut the retaining clip to remove the harness. Use care – Do not cut the harness. Disconnect the four (4) harness connectors. Release/remove the two (2) pushpins.



Connector

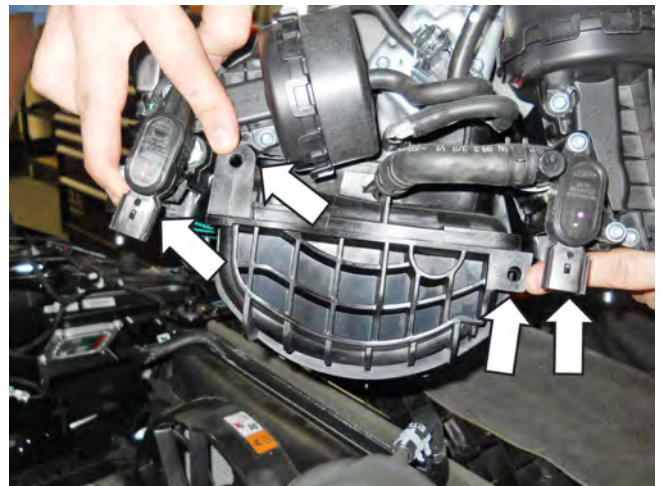
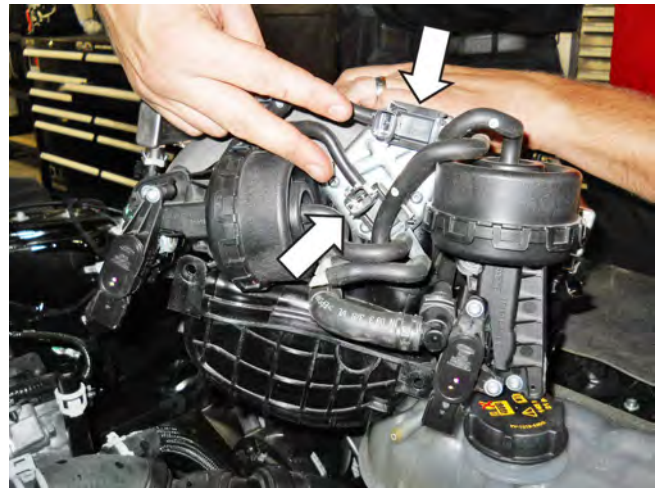

Harness push pin retainer points on rear of intake



Pin retainers on harness

43. Remove the intake manifold and fuel rail assembly from the vehicle. This hardware will not be reused.



45. Disconnect the vent hose from the engine coolant degas bottle and at the water pump inlet.



44. Clean the intake mounting surfaces and apply tape over the open intake ports to prevent engine contamination.



Degas vent



Degas hose from bottom of bottle

46. Remove the two (2) mounting bolts (10 mm socket) and remove the engine coolant degas bottle.



47. Disconnect the clamp on the end of the upper radiator hose at the radiator. Use a rag to catch excess coolant. On the thermostat housing end of the hose, push the clip down on the connector and remove the upper radiator hose from the vehicle.



Some coolant will still be inside the hose. Use a rag to catch coolant when removing the hose.



48. Loosen the water pump bolts.
49. Remove the front end accessory drive (FEAD) belt. Rotate the FEAD tensioner counter-clockwise to release the belt tension and remove the belt. Set the belt aside as it will be reused.



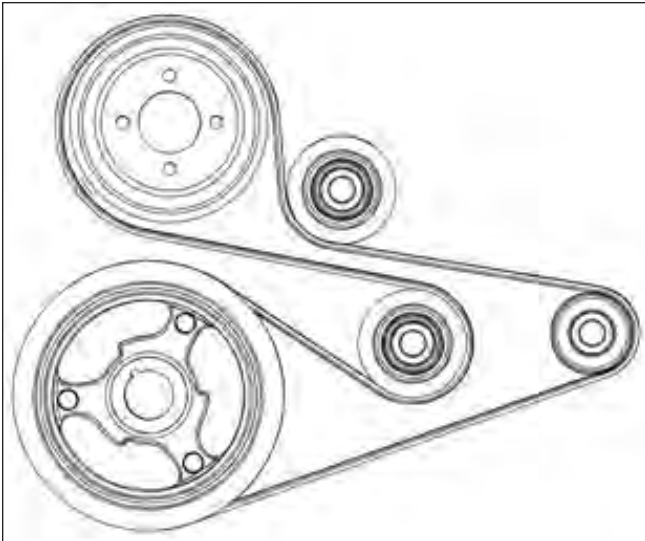

LH bolt

50. Disconnect the electric fan harness connector on the cooling module. Remove the two (2) bolts (10 mm socket) securing the shroud to the cooling module, then remove the electric fan and shroud assembly from the vehicle.



RH bolt



Fan shroud electrical connector



51. Remove the three (3) bolts securing the water pump pulley to the engine and remove the water pump pulley.



52. Cut and remove the A/C compressor belt.
Discard belt.



NOTE: Make sure to remove coolant to keep components clean as you continue procedures.

53. Unclip the engine electrical harness retention clips that retain the engine harness to the top corners of the RH (passenger side) front cover.

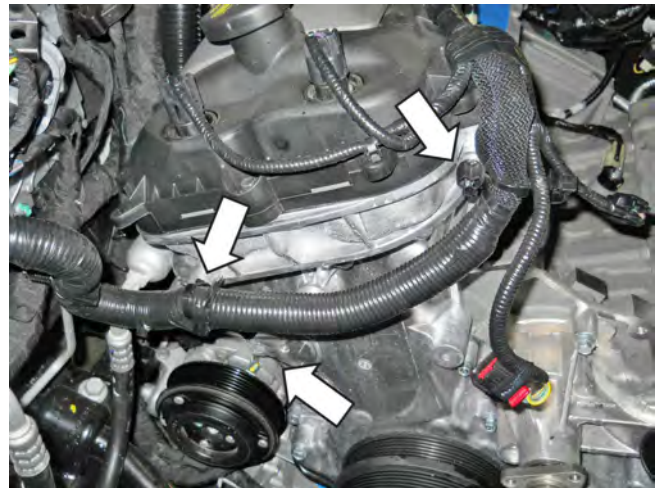

3-harness clip points

54. Loosen the clamp and disconnect the coolant hose, at the outlet neck.



55. Remove the two (2) bolts from the thermostat housing (8 mm socket).

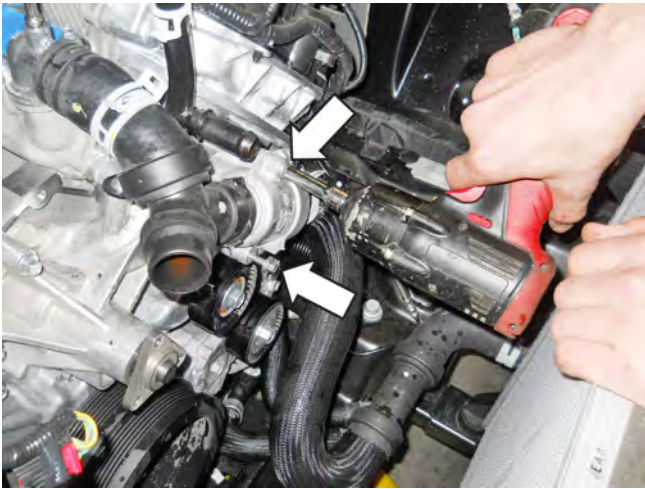

56. Remove the thermostat housing assembly and set it aside.

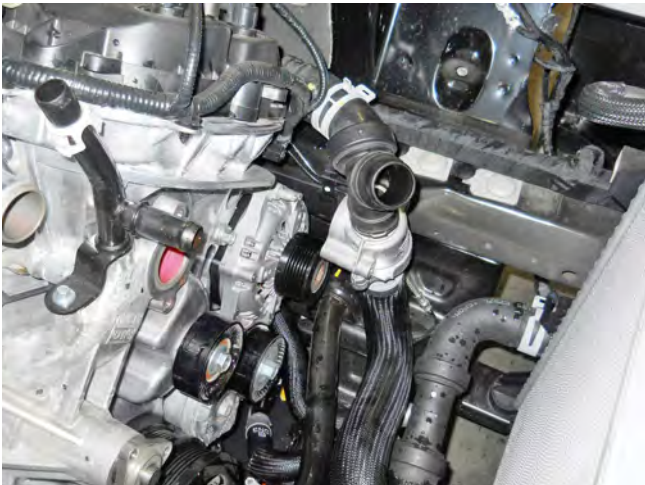

57. Remove the four (4) water pump mounting bolts (10 mm socket) and remove the water pump. Set both aside for re-use.



58. Place a clean towel in the water pump inlet cavity.



59. Cap or tape off the PCV port, heater feed tube and the heater core ports on the firewall.



61. Tape off and block the thermostat housing ports.
Use care to prevent coolant from leaking from the housing and hose.



60. Tape off the radiator hose port and inlet port.



SECTION B – MODIFICATIONS

The following section will guide you through the required modifications of existing components and build up of the assemblies used to complete the installation. With the exception of the wiring modifications and intercooler pump bracket mounting, all of this work can be performed away from the vehicle.

BRAKE BOOSTER VACUUM AND ASPIRATOR HOSE ASSEMBLY MODIFICATION

1. Retrieve the brake vacuum hose and aspirator assembly and place it on a work bench.
2. Disassemble the vacuum hose assembly and lay it out on the bench as shown in the following steps.

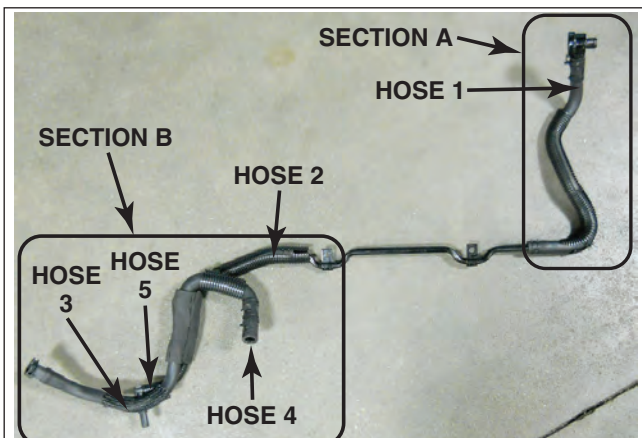

3. Release the clamp and remove Section A, hose 1, from the brake booster hose and aspirator assembly. Keep all clamps, they will be reused.
4. Release the clamp and remove the check valve from the straight end of hose 1.

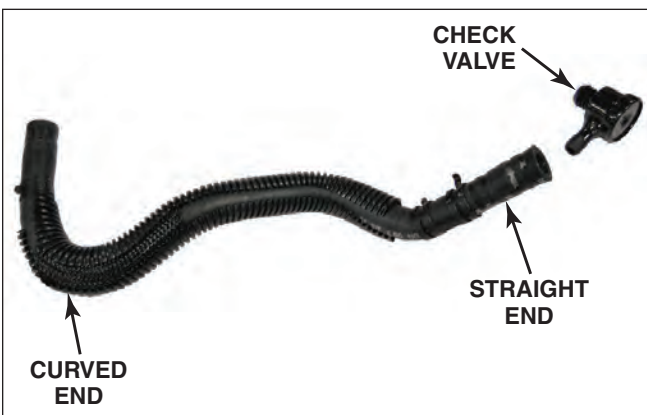

5. Return to Section B of the hose/tube assembly.

Carefully remove the foam sleeve from the brake aspirator.



6. Release the clamp and separate Section B, hose 2, from the steel tube. Disassemble the remaining brake aspirator assembly. Keep all clamps since they will be reused.



7. Use the supplied brake aspirator plug (CS2575) to plug the black port that is diagonal to the 1/2-inch grey port of the aspirator assembly. (The arrow indicates the 1/2 inch grey port.)



8. Use the takeoff clamps and attach them to the aspirator to brake booster hose (1315-9D690).



10. Install the line that goes from the supercharger to the aspirator assembly (1315-9D692) into the 1/2-inch grey fitting on the aspirator assembly.



9. Install the aspirator to brake booster line (1315-9D690) into the black port on the brake aspirator assembly. Then install the check valve that plugs into the brake booster.



11. Install the hose that goes to the clean air tube (1315-9D691) into the remaining port on the brake aspirator assembly.



12. Re-install the foam on the brake aspirator assembly as shown.



EVAPORATIVE EMISSIONS CANISTER PURGE LINE

1. Remove the convolute and carefully cut the quick connect fittings from both ends of the old EECPV line.

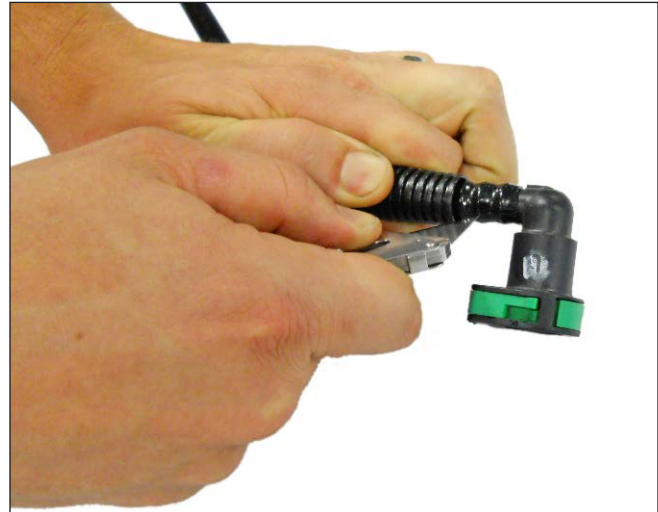

2. Install the protective hose sleeve (1150-18K579SLV) found in Hardware Kit D (1315-TVSHKD) over the 36" length of 3/8" rubber hose (1315-9G272).



3. Install one (1) clamp (7329K11) found in Hardware Kit D (1315-TVSHKD) onto each end of the new line. Install the quick connect fittings on the ends of the new line using the orientation shown. Secure the fittings with the clamps.



K-BRACE MODIFICATION

1. As described previously, mark the K-brace where it meets the windshield wiper close-out panel.
2. Use a suitable tool to cut the K-brace in the area marked.



3. Use a suitable tool to file the sharp end where the brace was cut.



Exposed point on modified K-brace, shown installed

4. Paint the cut area with suitable material to prevent corrosion.

ELECTRIC FAN SHROUD MODIFICATION

1. Place the IC degas bottle template (1315-DGSTMPL) on the top of the fan shroud and align it with the shroud features. Use a spring-loaded punch or other suitable tool to mark the fan shroud for modification. Remove the template.

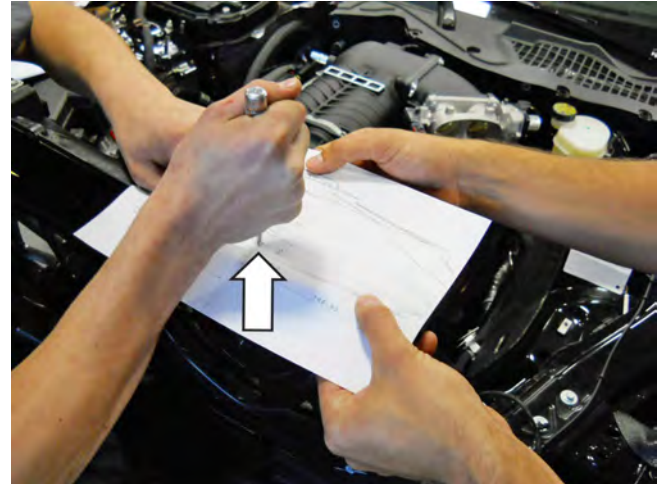

2. Use a dremel or other suitable tool to remove material in the three (3) rectangular areas marked as well as the two (2) holes.

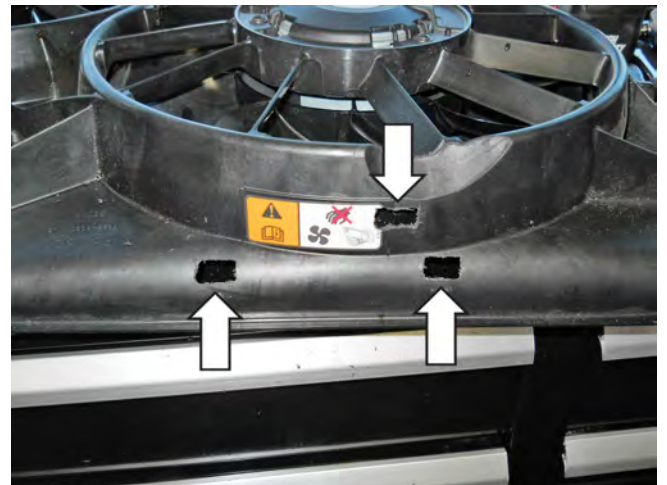

3. Install two (2) J-clips (N623332-M6) found in Hardware Kit H (1315-TVSHKH) in the two (2) areas on the edge of the shroud.



4. Insert the clip (20860) found in Hardware Kit H (1315-TVSHKH) onto the tab on the bottom of the intercooler degas bottle (1315-8D080).



5. Position the intercooler degas bottle to the fan shroud and check the fit, but do not install. Remove additional material as required so the bottle fits properly.

FRONT COVER MODIFICATION



Wear safe eye protection when grinding to prevent serious personal injury.

1. If not already done so, clean the engine surfaces with brake clean and dry with shop air.
2. Block off the grinding area to prevent debris and metal shavings from spreading through the engine compartment.

3. Using a grinder or cut-off wheel, modify the front cover in the areas shown. The two (2) bosses located at A and B need to be reduced in height such that they are flush, or lower than the height of the nearby rib structure. The boss located at C needs to be reduced in height and cut in half.

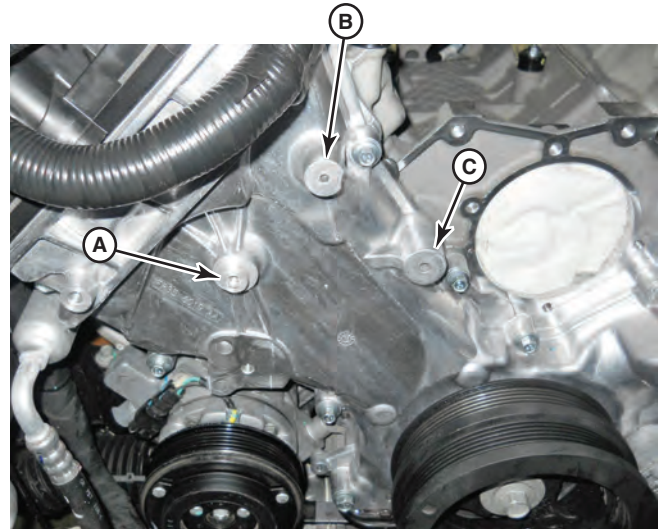

Before

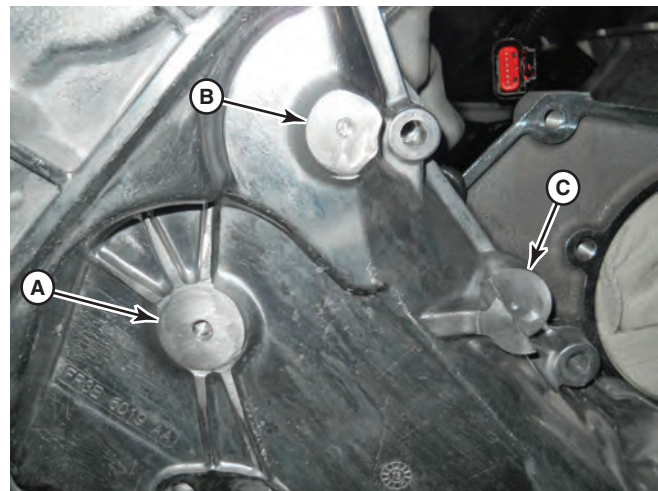

After

Surfaces A and B, must be lower than or equal to the adjacent rib height. Cut in half and remove material off of boss C until flush.

Refer to the following closeup example views for detail.

Crosshatched surfaces A and B must be lower than or equal to this rib height.



4. Remove the wiring retention clip from the feature on the front cover and set aside.



6. Deburr any rough edges on the cover and remove the retention harness from the wire harness.

INTAKE VALLEY MODIFICATION

1. Mark the boss in the intake valley behind the water pump mounting location as shown.



5. Using a suitable cutting tool, remove the mounting tab. Follow the edge of the part. Use caution as to not contact the cam covers.

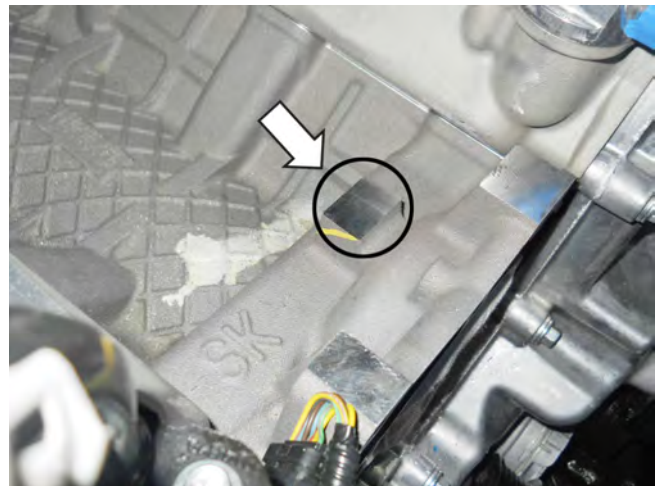

2. Use a grinder or suitable tool to grind the boss down across the entire length. Make sure to take off material uniformly along the angle. If high spots are left, the intake manifold will not seat properly on the engine.

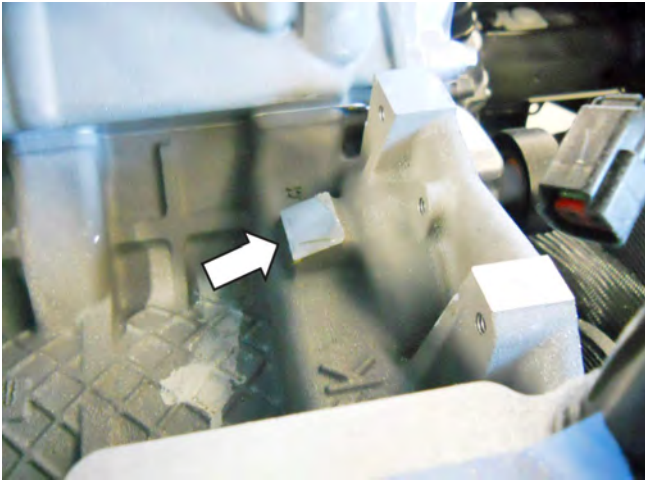

3. Vacuum out metal shavings.

TPS/ETC WIRING

NOTE: If the wire harness included in the kit is 131114A595-CA, skip steps 1-3. Do not de-pin, not necessary!

1. Locate the throttle position sensor (TPS) (6-wire) connector and harness at the front of the passenger side cylinder head. Using a proper de-pinning tool, pop out the locking tab and remove the connector from the harness.



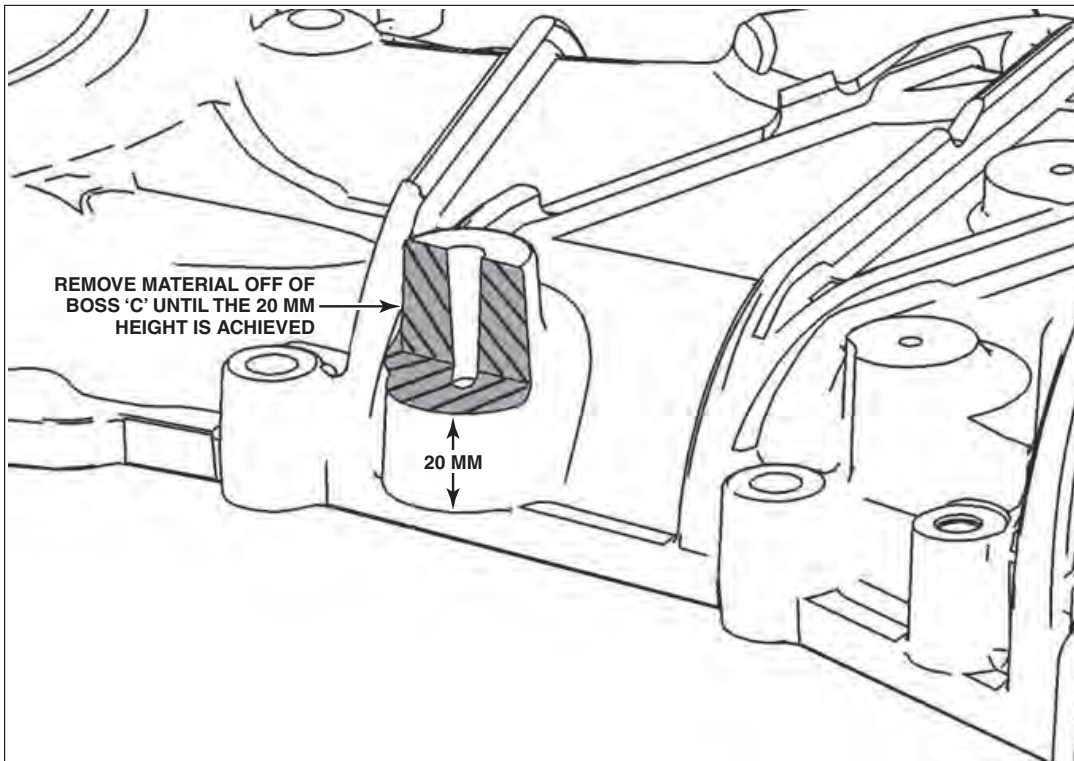
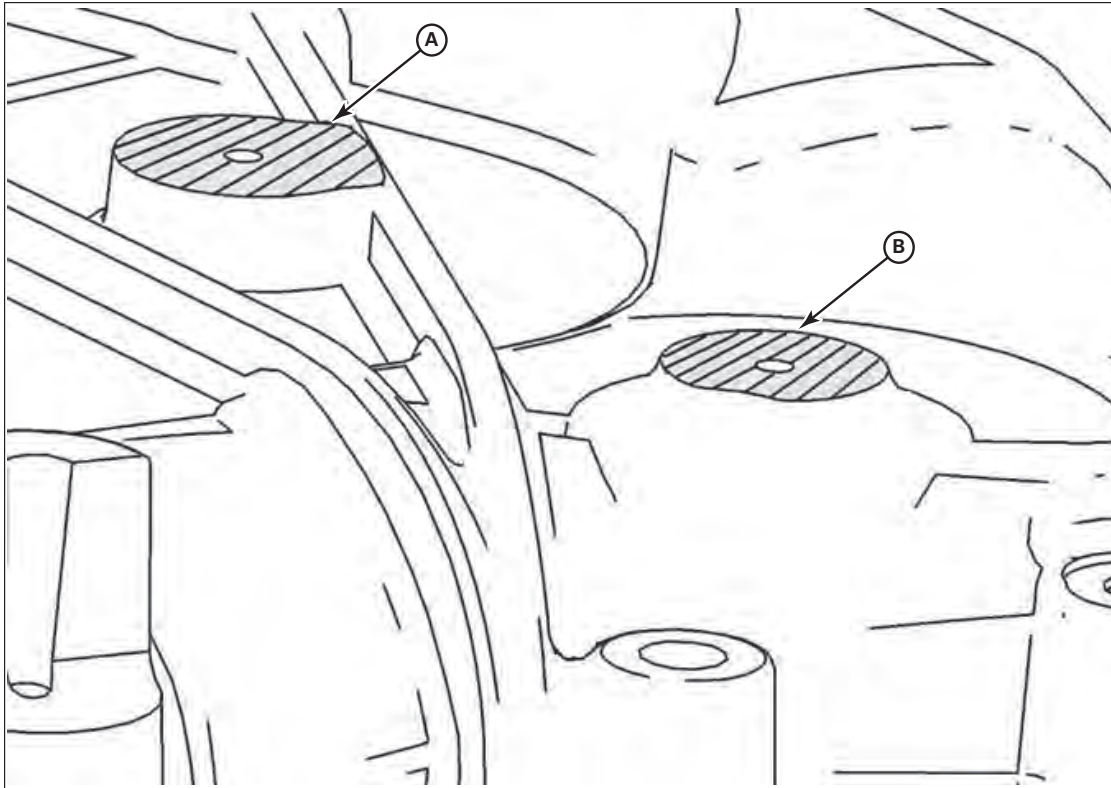

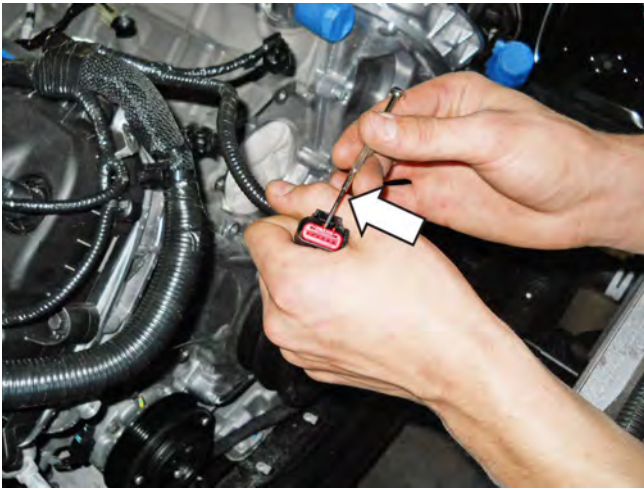

2. Depress the locking tab and separate the “empty” female 1 x 6 connector from the new TPS/ETC extension harness (131114A595). It will be used in the next step.



3. Populate the new connector such that the yellow with violet wire is in position 1, the blue with green wire is in position 2, the brown wire is in position 3, the blue with orange wire is in position 4, the yellow wire is in position 5 and the green with violet wire is in position 6. Install the red plastic lock into the connector to secure the wires in place.

4. Connect the TPS/ETC extension harness (131114A595) from Hardware Kit E (1315-TVSHKE) to the newly installed connector. The wire colors on each side of the connector pair should align. Route the harness along the main wiring harness to the rear of the driver side cam cover. Use tape or zip ties to secure the extension harness to the main harness.



EVAPORATIVE EMISSIONS CANISTER PURGE VALVE WIRING

1. Locate the evaporative emissions canister purge valve electrical connector (2-wire) at the front of the passenger side cylinder head. Use a proper de-pinning tool to remove the connector from the harness.



2. Depress the locking tab and separate the “empty” female 1 x 2 connector from the evaporative emissions canister purge valve extension harness (13119G866). This connector replaces the connector removed in the previous step. Carefully pull the white locking tab forward to allow wires to be installed into the connector. Populate the new connector such that the white with brown wire is in position 1 and the green wire is in position 2. Depress the white locking tab to secure the wires.



3. Connect the evaporative emissions canister purge valve extension harness (13119G866) to the newly installed connector. The wire colors on each side of the connector pair should align. Route the harness along the main wiring harness to the rear of the passenger side cam cover. Use tape or zip ties to secure the extension harness to the main harness.



AIR CHARGE TEMPERATURE (ACT) WIRING

1. Locate the IMRC sensor connector (light grey) at the rear of the passenger side cylinder head.
2. Connect the IMRC sensor connector into the ACT wiring harness (1315-12A690), found in Hardware Kit E (1315-TVSHKE).



3. Route the extension wiring harness to the RH side cylinder head.
4. Install the connector block (1315-14A464), found in Hardware Kit E (1315-TVSHKE), into the IMRC 3-pin sensor connector (dark grey) located at the rear of the driver side cylinder head.



TPS/ETC AND EECPV HARNESS ROUTING

1. Remove the wiring retainer and clip on the engine harness.



2. Route both extension harnesses along the engine harness. Secure them in place with zip ties.

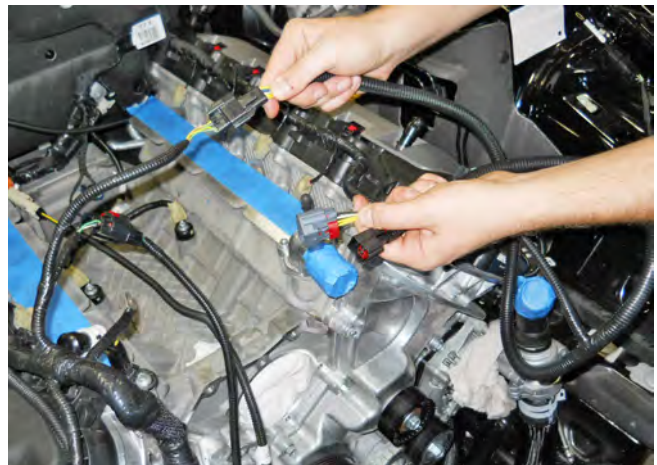

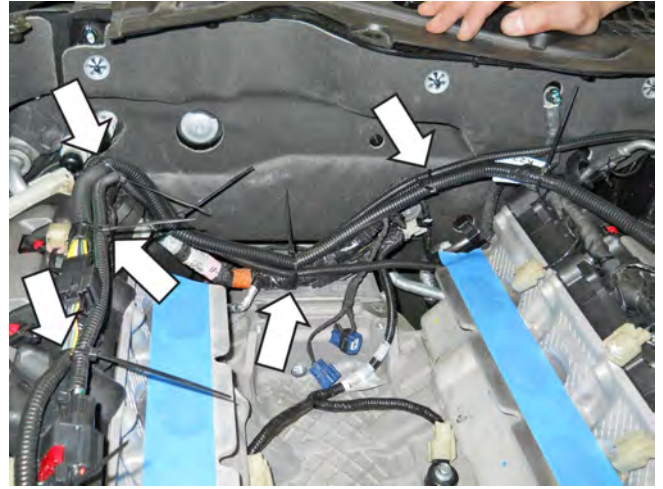

3. When complete, the secured harnesses will look similar to this. Trim the excess length from the zip ties.

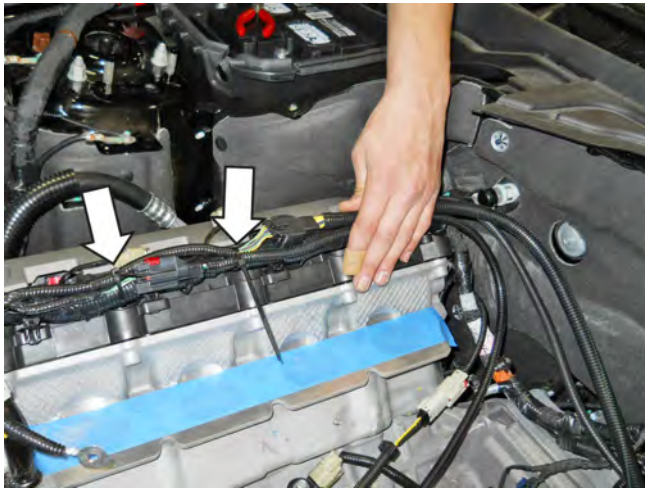

4. Wrap electrical tape around the two (2) blue CMCV connectors at the rear of the cylinder head as shown.

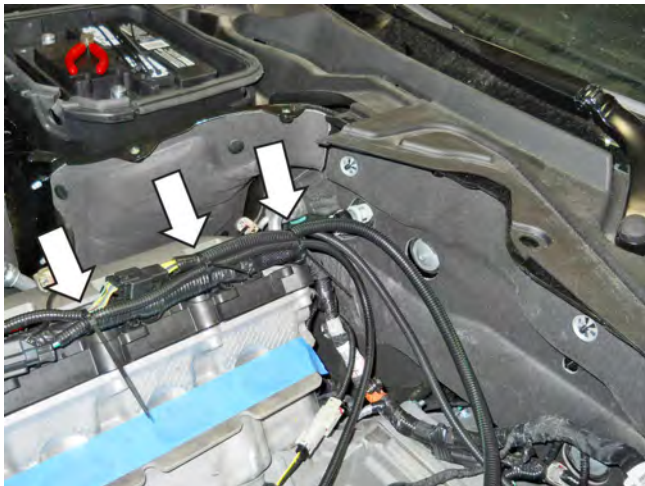

CMCV connectors taped up

ENGINE HARNESS GROUND WIRE

1. Pry up the engine harness retainers at the RH front and side of the engine.



2. Peel back the insulation at the base of the ground wire that was attached to the stud on the front cover. Trim back part of the insulation until the ground wire is exposed.



3. Separate the ground wire further back into the harness. This will create slack necessary for relocating the ground.
4. Rewrap the ground wire with electrical tape.



5. Use snips to cut off the bent metal tab on the end of the ground tab.



- Using a step bit, drill the hole on the tab to enlarge the opening. The hole must be larger to accommodate a larger bolt.

TIP: Hold the tab with pliers when drilling to keep the tab stationary.



Relay bolt, front side

INTERCOOLER PUMP WIRING

2015-2016 Mustang

- Lift up the fuse box by releasing the two (2) retaining tabs and locate the hole underneath the fuse box near the PCM. The intercooler pump relay will be attached at this location.



Relay mounting nut as viewed from inside the wheel well opening

- Install the relay and fuse from the Intercooler pump wiring harness (1315-8W501) through the hole and secure it with one (1) M6 x 14 bolt (N605771) and one (1) M6 nut (W520412). These parts can be found in Hardware Kit E (1315-TVSHKE).

- Lay the intercooler pump wire harness along the engine harness, in back of the cylinder head to the driver side inboard cylinder head. Disconnect the radio capacitor and plug the intercooler pump harness in line with this connector.



4. Route the intercooler pump wire harness in back of the cylinder head along the RH engine harness to the area near the fuse box.

6. Install the ground wire with the existing ground wire near the RH strut tower and retighten the bolt to 10 Nm. Coil up the extra wire slack.



5. Install the intercooler pump harness red power wire to the first post in the fuse box. Tighten the nut to 10 Nm.

7. Route and tuck the intercooler pump harness under the engine harness and down the RH coil cover towards the fuse box as shown. Secure it in place with zip ties.

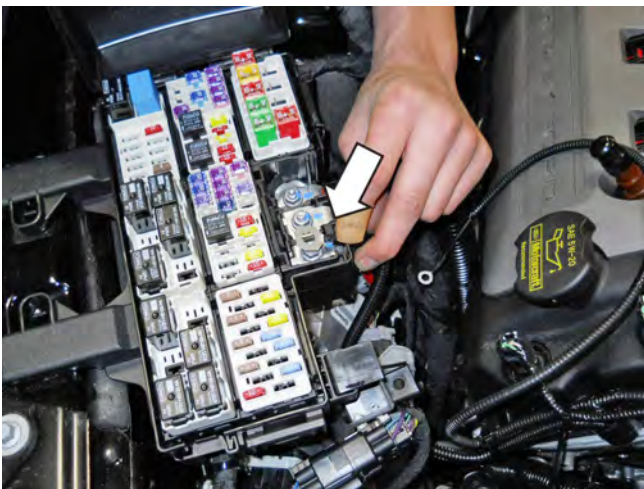



8. Retain the engine harness to the front cover using the zip tie with fur tree (156-00329) found in Hardware Kit E (1315-TVSHKE).

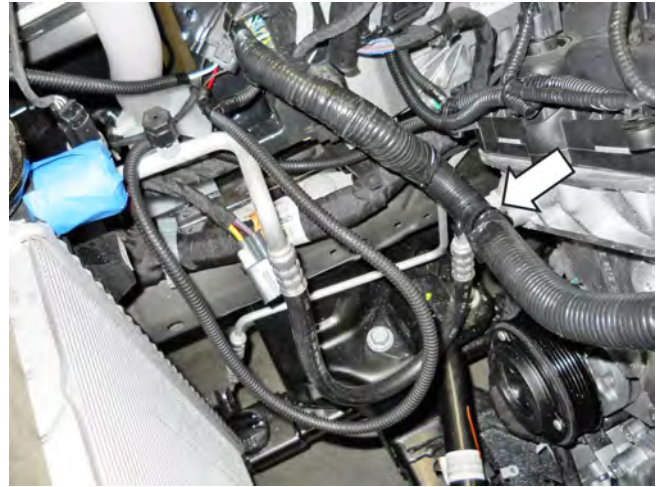

9. Route the intercooler pump wire harness over the top and in front of the wiper washer bottle. Secure it in place with zip ties as necessary.



10. Zip tie the excess harness out of the way and secure it to a safe location.



2017 Mustang

1. Install the relay and fuse from the intercooler pump wiring harness (1315-8W501) to each stud protruding from the battery box. Put the relay on the upper stud, and the fuse on the lower stud as shown.



2. Apply blue Loctite (or equivalent) to two (2) M6 nuts (W520412) and secure to the studs.
3. Torque to 5-10 Nm.
4. Lay the intercooler pump wire harness along the engine harness, in back of the cylinder head to the drivers side inboard cylinder head. Disconnect the radio capacitor and plug the intercooler pump harness in line with this connector.



5. Route the intercooler pump wire harness in back of the cylinder head along the RH engine harness to the area near the fuse box.



6. Install the intercooler pump harness red power wire to the first post in the fuse box. Tighten the nut to 10 Nm.



7. Install the ground wire with the existing ground wire near the RH strut tower and retighten the bolt to 10 Nm (coil up extra wire slack).



8. Route and tuck the intercooler pump harness under the engine harness and down the RH coil cover towards the fuse box as shown. Secure it in place with zip ties.



9. Retain the engine harness to the front cover using the zip tie with fur tree (156-00329) found in Hardware Kit E (1315-TVSHKE).

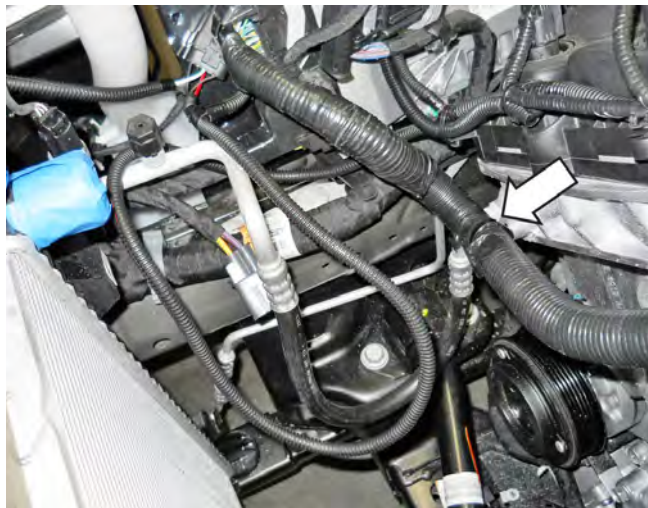

10. Route the intercooler pump wire harness over the top and in front of the wiper washer bottle. Secure it in place with zip ties as necessary.



KNOCK SENSOR ORIENTATION ADJUSTMENT

The knock sensors must be reoriented and the harnesses rewrapped to accommodate the new fuel charging assembly. It will be necessary to split the two (2) sensor wires further up the harness in order to gain the necessary slack for proper sensor positioning towards the side of the engine valley.

1. Remove the 90-degree plastic wiring retainer clipped to the connector and taped to the wiring convolute.

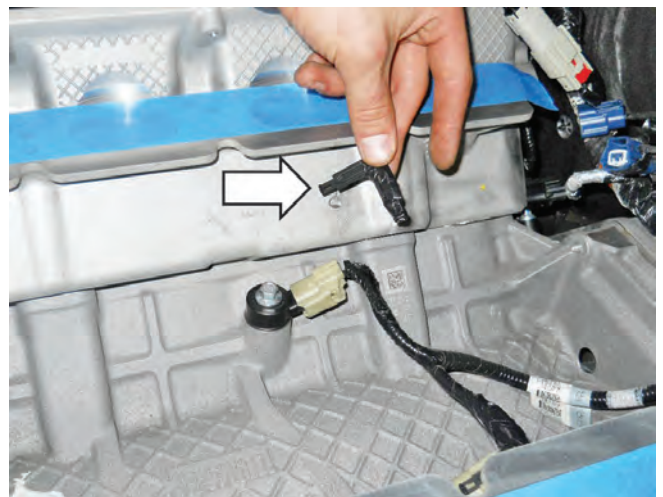

2. Loosen the two (2) bolts which retain the knock sensors to the engine block (10 mm socket). If necessary, one (1) of the bolts and sensors can be removed for this modification process.
3. Peel back the tape from the connectors and remove the convolute approximately 1-1/2" past where they meet at the harness.



CHANGING THE FACTORY SPARK PLUGS

1. Remove the coil covers by gently pulling up on them. Remove the oil cap prior to removing the RH coil cover.



2. Disconnect the electrical connectors for each ignition coil (eight [8] places).

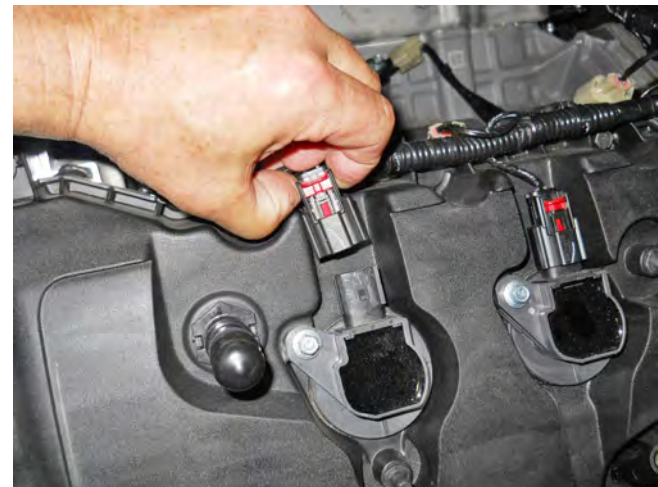

4. Temporarily fit the sensors as follows to determine where to rewrap the wires. Install and rotate the RH and LH knock sensors as far as possible to the outside of the valley of the block. Check that the sensors lay low on the engine valley so they will not interfere with the fuel charging assembly once it is installed.



3. Remove the eight (8) fasteners holding the coil on plug assemblies in place (8 mm socket). Save the fasteners for re-use.

5. Reinstall the convolute and rewrap the wires with electrical tape as required.
6. Install the knock sensors in position. Install the bolts and torque them to 20-30 Nm.



4. Remove the coil on plug assemblies and label them so they can be reinstalled in their original position. A slight twisting motion will break the seal and ease removal.



6. Unpack the eight (8) provided spark plugs (M-12405-M50), **YOU MUST RE-GAP PLUGS TO 0.9 mm (.035")** and verify that the plugs are not damaged. Check to ensure the gap is intact and none are damaged.



5. Use a 5/8" spark plug socket and 6" extension to remove the eight (8) factory spark plugs and set aside. These will not be re-used.

NOTE: Use a universal swivel socket at the rear RH plug.



7. Install the new spark plugs using a 5/8" spark plug socket and 6" extension. Torque to 14 Nm.

NOTE: Use a universal swivel socket for the RH rear plug.



8. Apply a small amount of dielectric grease to the inside of the coil on plug boots before attaching to the spark plugs. Install the ignition coil on plugs in their original position. Install the coil on plug bolts and torque to 6 Nm.

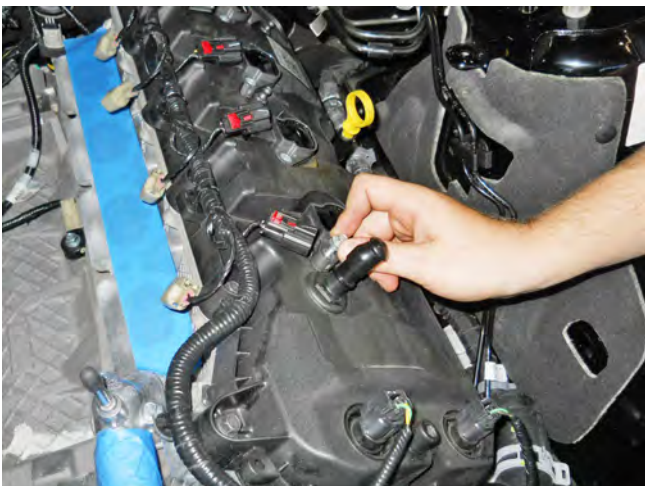

9. Connect the electrical connectors for each ignition coil eight (8) places.



10. Re-install the coil on plug covers. Reinstall the oil cap after the RH cover is installed.



11. Locate the two (2) spark plug warning labels (PT00045644, found in 1121-HWKF). Place 1 label on cylinder 1 and cylinder 5 coils (front coil of RH and LH cam cover).



SECTION C – SUBASSEMBLY

INTERCOOLER LOW TEMPERATURE RADIATOR (LTR)

1. Insert one (1) rubber grommet (R07060107) found in Hardware Kit H (1315-TVSHKH) into each lower tab on the low temperature radiator (ltr) assembly (1315-8K229).



2. Push one (1) sleeve (R07060108) found in Hardware Kit H (1315-TVSHKH) into each of the rubber grommets.

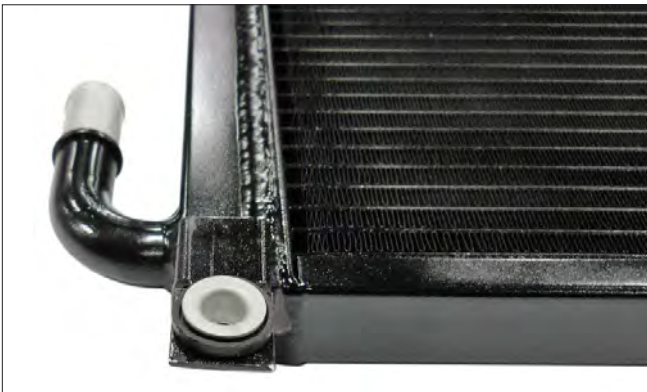

INTAKE MANIFOLD BUILDUP

1. Remove the PCV purge hose (13116K817) from the packaging. Release the clamp and separate the rubber section of hose as shown.



2. Attach the rubber hose section from the PCV Purge Hose to the bubbler fitting (3/8" barb) on the bottom rear of the intake manifold (1315-9H487) and secure it with the supplied clamp.



SUPERCHARGER BUILDUP

1. Remove the two (2) bolts and the evaporative emission canister purge valve from the stock intake manifold (8 mm socket). Discard the bolts.



2. Install the valve into the rear of the supercharger (1315-6F066) using two (2) M6 x 1.0 x 35.5 mm bolts (N808429) found in Hardware Kit B (1315-TVSHKB). Torque bolts to 8-12 Nm.

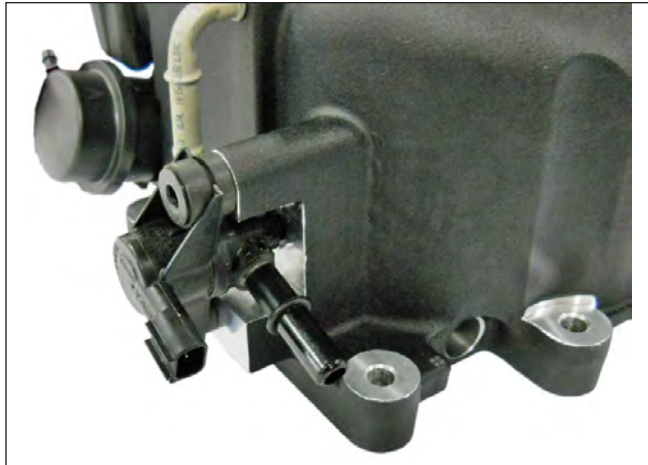

3. Connect the supercharger boost bypass actuator hose (1315-9E498) found in Hardware Kit D (1315-TVSHKD) to the top port on the actuator and route to the small port on the supercharger.



4. Connect the brake boost hose to the 90-degree tube at the rear of the supercharger and secure it with the clamp. This is “hose 1” created from the brake boost vacuum and aspirator assembly modification process.



5. Connect the supercharger bypass reference vacuum line (7R3V-9E498) to the bottom fitting on the supercharger bypass actuator.

NOTE: This line will later be routed underneath the heater hose and fuel line.



6. Install the supercharger badge (1315-6F066BDG) onto the top of the supercharger.

FUEL RAIL ASSEMBLY

1. Carefully install the eight (8) new anti-rotation fuel injector clips (1311-9C995) onto the new fuel injectors (13119F593K fuel injector kit).

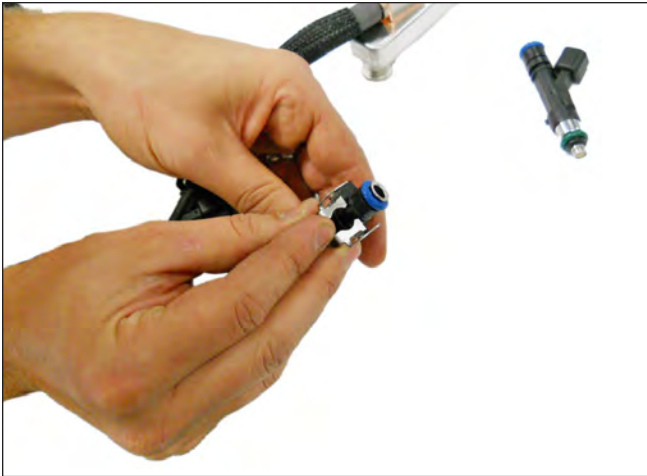

2. Apply assembly lube to the injector O-rings and install the injectors into the new fuel rail (1315-19F792).

NOTE: Verify that the anti-rotation clips are properly aligned and fully engaged into the fuel rail injector cups.

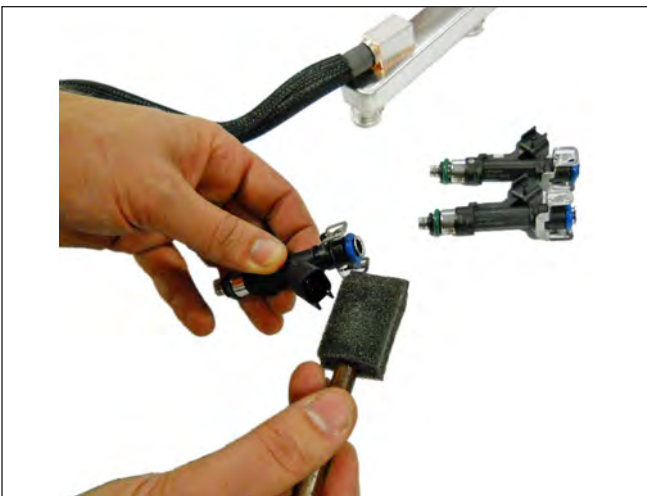

AIRBOX ASSEMBLY

1. Insert the dirty air duct (1315-9F763) and install it into the lower airbox tray (1315-9A612) as shown.

NOTE: These may be separated if needed to ease installation to the vehicle.



2. Insert the two (2) J-clips (W520823) from Hardware Kit A (1315-TVSHKA) onto the airbox tray as shown.



3. Place the MAF tube assembly (1315-12B579HC) through the opening of the airbox tray from the inside.



4. Align the holes on the MAF tube assembly with the J-clips on the airbox tray. Install two (2) bolts (W500224) (M8 X 25) from Hardware Kit A (1315-TVSHKA) and torque to 10 Nm (10 mm socket).



5. Install the filter (1315-9601R) onto the MAF tube and secure it with the supplied clamp. Torque clamp to 3-5 Nm.

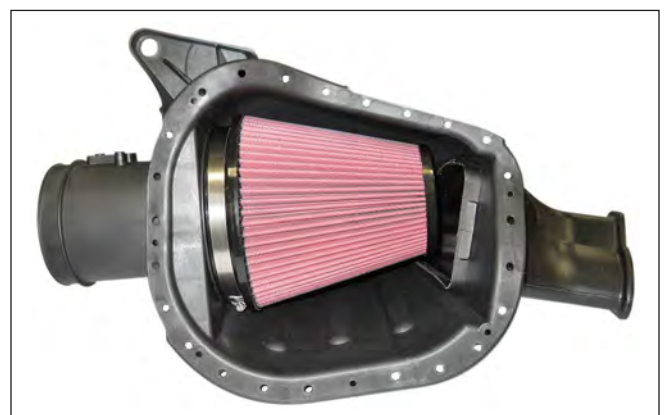

6. Remove the MAF sensor from the factory airbox lid. Retain the bolts for reuse.

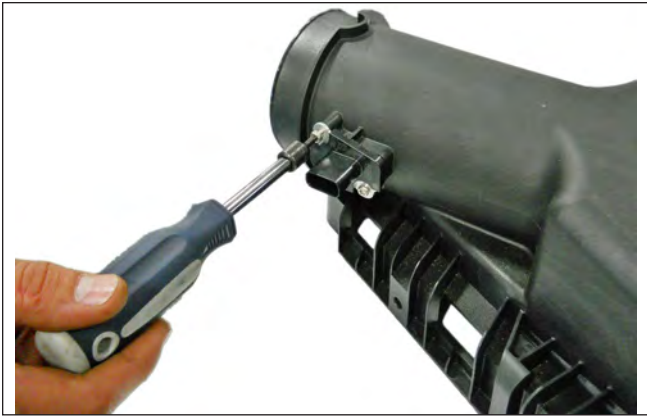

7. Transfer and install the factory MAF sensor into the MAF tube assembly using the original MAF sensor bolts (M4 X 0.7 X 10) and tighten with a T-20 Torx bit. Torque the screws to 1.8–2.2 Nm. Be careful not to over tighten these screws. Wiggle the MAF sensor to ensure that it is properly fastened.



8. Install the upper airbox cover (1315-9643) on the airbox tray. Using a T-30 Torx head bit, install six (6) bolts (W506976) from Hardware Kit A (1315-TVSHKA).



9. Remove the grommets and sleeves from the factory lower airbox. Install the grommets and sleeves onto the new airbox assembly.

TIP: Remove the center bushing while installing the rubber grommet through the hole in the tab. Re-install the center bushing once the grommet is fully seated.



10. Remove the rubber mounting isolator from the bottom of the factory airbox and install it onto the mount on the bottom of the new airbox in the same orientation.



INTERCOOLER PUMP BRACKET

1. Apply 1" foam strips (1318-8D082, found in 1318-TVSHWKH) to the inside of the two (2) intercooler pump upper brackets (1318-8C4192, found in 1318-TVSHWKH).



2. Apply two (2) 1"-size foam strips (1318-8D082) to the inside of the intercooler pump lower bracket (1318-8C4191, found in 1318-KIT1).



SECTION D - INSTALLATION

The following section will guide you through the final installation of the kit into the vehicle. If you need to stop during any part of the installation, make sure you cover any open ports in the cylinder heads or intake manifold to prevent foreign material from contaminating your engine.

INDUCTION RESONANCE TUBE DELETE GROMMET

1. Obtain the induction resonance tube delete grommet (W651016) from Hardware Kit A (1315-TVSHKA).
2. Install the induction resonance tube delete grommet in the hole that was exposed when the resonance tube was removed.



NOTE: If the ROUSH boost gauge kit is going to be installed onto the vehicle, the above grommet can be left out as the boost gauge kit has a pre-installed grommet on the vacuum line that will go in this location.

INTAKE MANIFOLD, FUEL RAILS, SUPERCHARGER, SPACER AND THROTTLE BODY

1. Remove the tape from the cylinder heads and clean the cylinder head to intake manifold mating surfaces.
2. Install the fuel charging assembly (1315-9H487) and check to make sure it is seated completely. If not, remove it and grind the modified area in the engine valley again until the manifold seats properly.

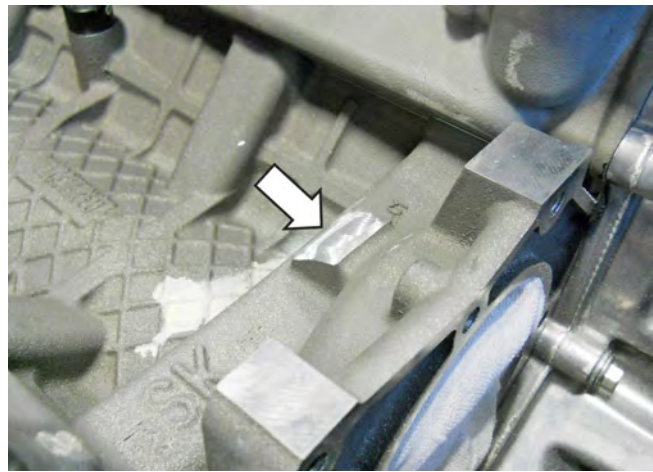
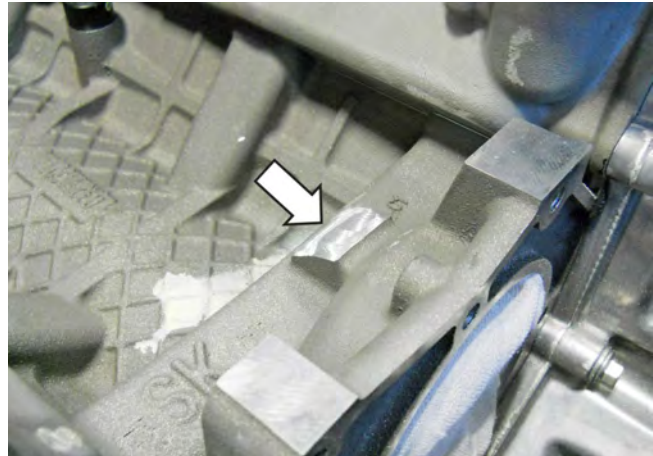

Grind area if intake won't seat

3. Install the engine harness ground wire tab at the RH front of the intake manifold using one (1) of the M6 x 1.0 x 40 mm bolts (R18020004) found in Hardware Kit B (1315-TVSHKB). Do not tighten the fastener down until the next step. Zip tie the ground wire to the engine harness.



4. Install the other five (5) M6 x 1.0 x 40 mm bolts (R18020004) found in Hardware Kit B (1315-TVSHKB) in the positions shown. Tighten the fasteners in two stages with the sequence shown. Stage 1; torque bolts to 10 Nm. Stage 2; tighten bolts an additional 45 degrees. Reinstall the engine wiring harness retention clips at the rear of the intake manifold.

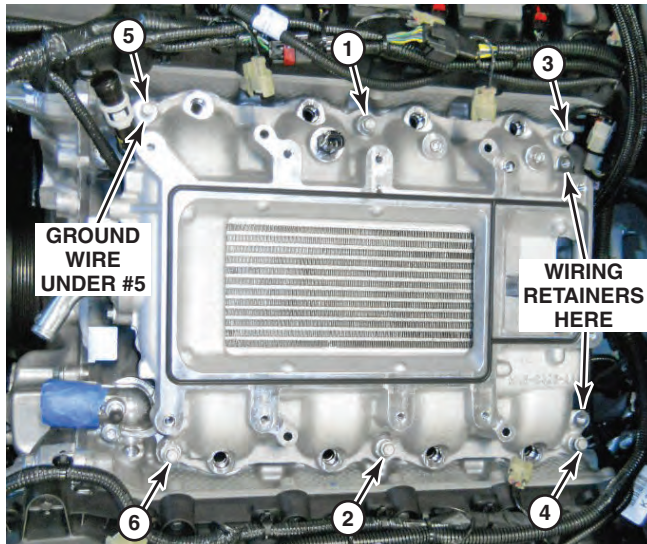

5. Check that the hose in back of the intake manifold is routed around the electrical harness and towards the RH cam cover.

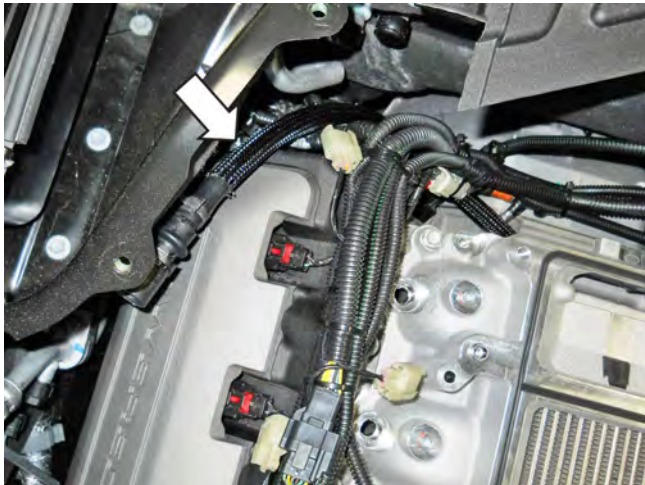

6. Connect the ACT sensor from ACT harness (1315-12A690) to the intake manifold.

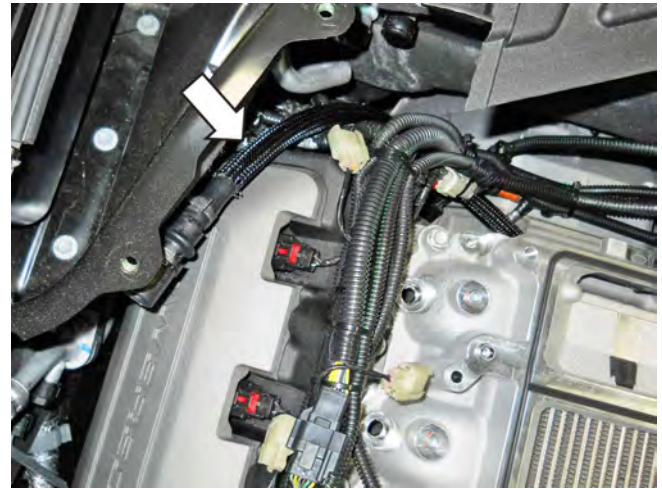

7. Lube the lower fuel injector O-rings with assembly lube. Install the fuel rail and injectors into the intake manifold. Be sure each injector is properly seated into the intake manifold. Install the previously removed fuel rail mounting bolts. Tighten the fasteners in two stages with the sequence shown. Stage 1; torque bolts to 10 Nm. Stage 2; tighten bolts an additional 45 degrees.

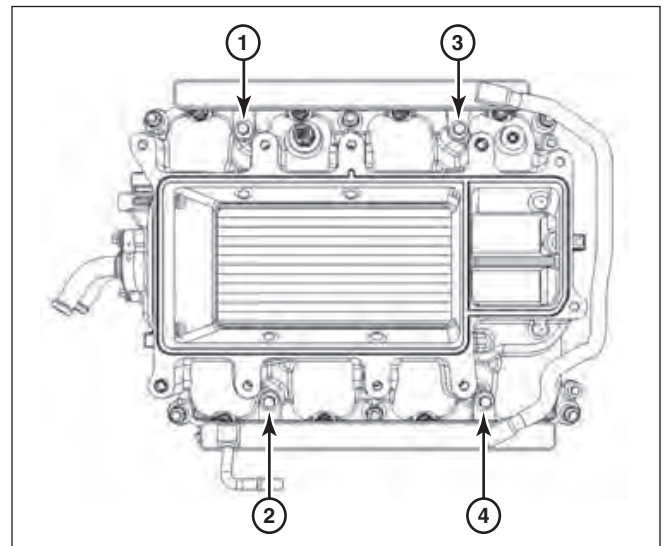

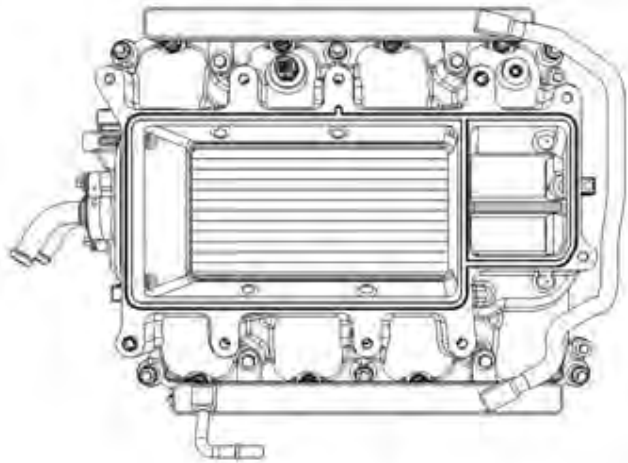

8. Connect the eight (8) fuel injector electrical connectors.



9. Carefully place the supercharger assembly (1315-6F066) on top of the intake manifold. Ensure that the supercharger is fully seated on the intake mounting dowels. Remove protective shipping covers.



10. Install the ten (10) M8 x 1.25 x 53 Fasteners (N808130) provided found in Hardware Kit B (1315-TVSHKB) into the mounting holes. Torque fasteners to 25 Nm in the sequence shown (10 mm socket).

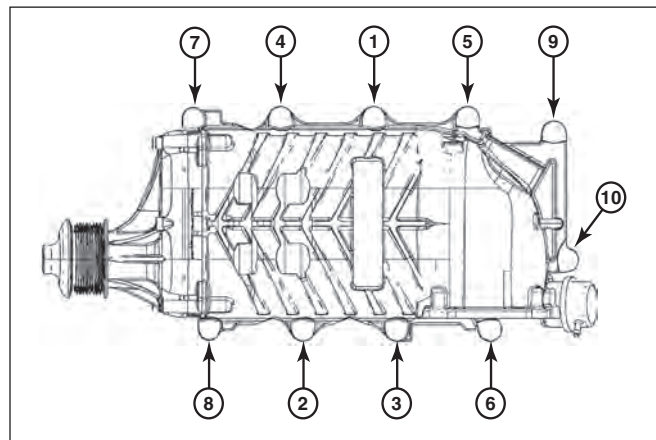
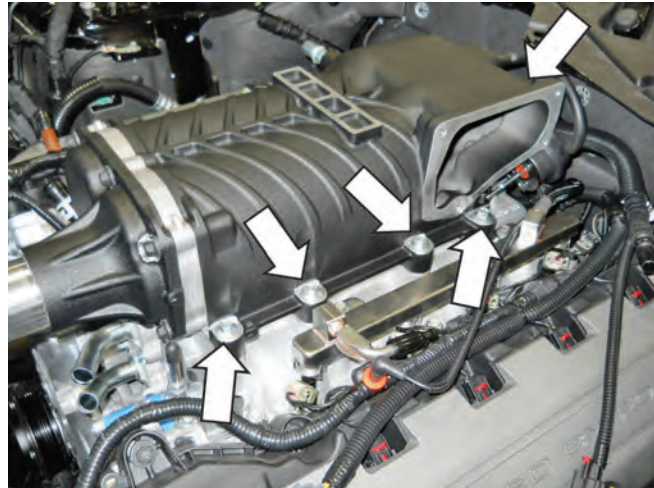
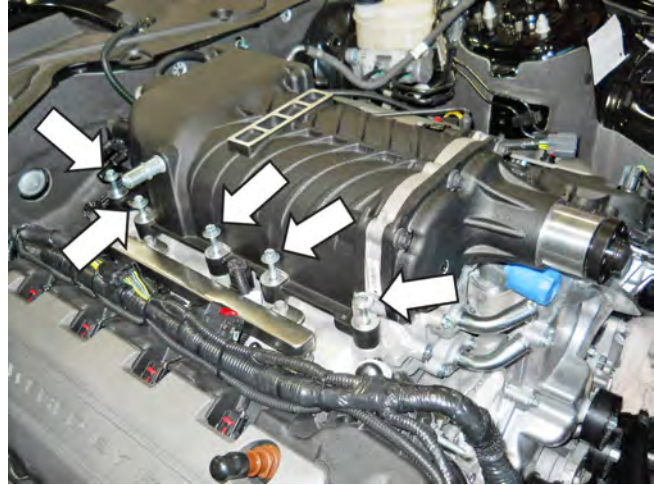

11. Install the 80 mm supercharger pulley (1313-6K80) onto the hub of the supercharger using the six (6) M6 x 16 bolts (W500013) found in Hardware Kit B (1315-TVSHKB). Apply a small amount of blue thread locking compound to each bolt and torque to 8-12 Nm.

HINT: You may need to torque the supercharger pulley bolts once the FEAD belt is installed.



12. Disconnect the negative battery terminal.
13. Access the vehicle rear seats. Locate the rear seat-bottom removal tab illustrated below (there are two [2] tabs, one on the passenger side, and one on the driver side). Remove the rear seat bottom by pushing on each plastic tab and pulling the seat-bottom upward and out.



14. Disconnect the vehicle harness from the fuel pump module.



15. Remove the spare tire well cover and the emergency tire repair kit.



16. Remove the plastic taillight closeout panel. (There are four end caps holding the closeout panel on.)



17. Using the fuel pump voltage regulator as a template, mark the four (4) mounting holes on the driver's side of the spare tire wheel well as shown.

19. Using the #8 self-tapping screws, attach the fuel pump voltage regulator to the wheel well.



18. Using the 1/8" drill bit, drill the four (4) locations marked.

20. Attach the ground strap to the chassis ground of the driver side of the trunk.



21. Plug the intermediate harness into both the factory wiring harness and the fuel pump module.



22. Run the two-pin connector from the trunk well along the driver side panel to the fuel pump module.



23. Connect the feed to the intermediate fuel pump harness connector. Make sure the harness is pointed out of the way of the rear seat cushion.



24. Re-install the emergency tire repair kit, the taillight closeout panel and the spare tire well carpet.



25. Install the brake aspirator hose assembly. Connect the hose (with 1/2" barbed fitting) from the supercharger to the 1/2" brake line and secure it with the attached clamp.



26. Connect the check valve on the brake vacuum and aspirator assembly to the brake booster.



27. Inspect the installation of the brake boost vacuum and aspirator assembly in the vehicle to ensure there are no pinched hoses and the convolute is positioned to prevent hose abrasion from other components.

28. Install the spacer-to-supercharger gasket (1315-9E152) found in Hardware Kit B (1315-TVSHKB) on the throttle body spacer (1315-9P697) as shown.



29. Install the spacer-to-throttle body gasket (R07060153-13) found in Hardware Kit B (1315-TVSHKB) as shown.



30. Mount the throttle body spacer (1315-9P697) using four (4) M6 x 32.5 fasteners (R18020009). These parts can be found in Hardware Kit B (1315-TVSHKB). Torque the fasteners to 10 Nm.



31. Connect the fuel supply line to the fuel rail and lock it into position.



32. Install the throttle body assembly (R07060150) on the throttle body spacer. Use four (4) M6 x 32.5 mm bolts (R18020009) found in Hardware Kit B (1315-TVSHKB) to secure the throttle body assembly to the spacer. Torque bolts to 10 Nm.



33. Install the ETC and TPS electrical connectors to the throttle body.



ETC



TPS

34. Plug the evaporative emission canister purge valve extension harness (13119G866) electrical connector into the relocated evaporative emission canister purge valve on the back of the supercharger.



35. Install the evaporative emission canister purge valve line to the body line tube below the brake booster. Slide the green clip to lock the connector. Route the rest of the line behind the cylinder head to the RH rear of the supercharger.



37. Connect the heater hose assembly (1315-18K579) to the heater tube near the front of the LF cylinder head.



38. Route the line around the front of the engine underneath the snout of the supercharger towards the heater core. Remove the top intercooler tube bolt and install the P-clamp tab using the fastener on the intercooler coolant inlet.

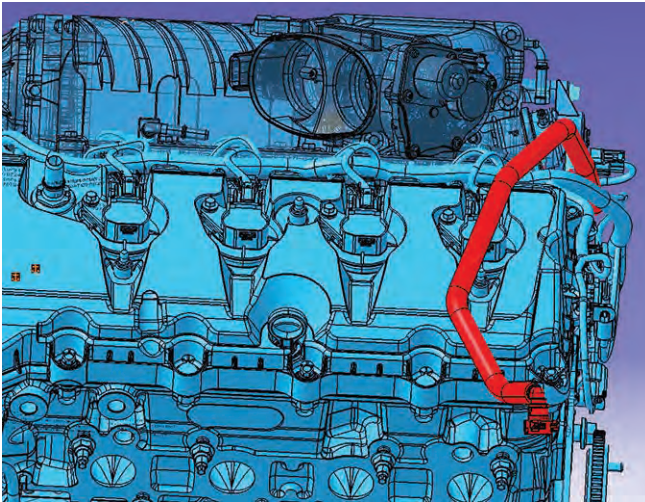

36. Connect the new evaporative emission canister purge valve line (1315-9G271), to the relocated evaporative emission canister purge valve on the back of the supercharger. Slide the green clip to lock the connector. **Make sure the hose is routed away from any hot surfaces.**



39. Route the hose along the RH fuel rail and down to the heater outlet at the firewall.





40. Install the heater hose connector to the bottom port (heater outlet) at the RH firewall.



41. Install the 424mm length of protective hose sleeve (1311-18K579) found in Hardware Kit D (1315-TVSHKD) over the RH factory heater hose and secure with tape on either end of the sleeve. Reinstall the RH factory heater hose to the tube at the RH front of the engine.



Outlet hose moved to show hose plug underneath

42. Route the hose along the top of the RH fuel rail and connect it to the top heater core port (inlet) on the RH firewall.



43. Secure the heater inlet hose to the new heater outlet hose assembly with zip ties.

44. Install the end of the PCV purge hose (13116K817) from the hose section previously disassembled onto the bottom rear fitting of the intake manifold. Install the clamp.

NOTE: Make sure both sides of the heater hose connections are locked onto the fitting. Pull on the hose to make sure the connection are secured.



45. Connect the PCV purge line (13116K817) to the PCV valve on the RH cam cover and the port on the RH side of the supercharger.

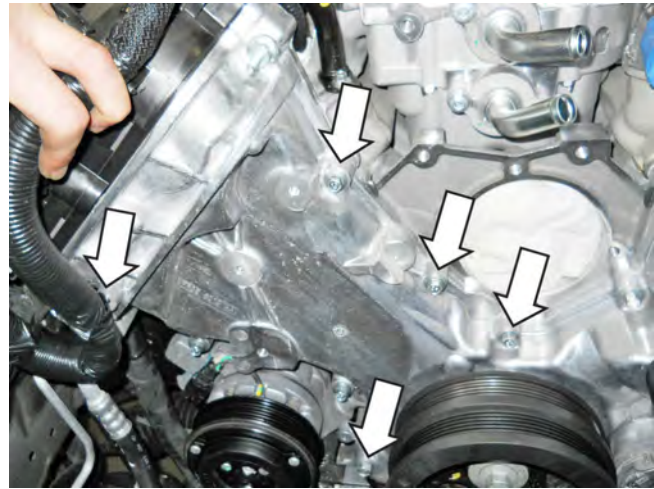

2. Lube the water pump gasket.



FEAD ASSEMBLY

1. Remove the four (4) bolts and one (1) stud from the front cover as shown.

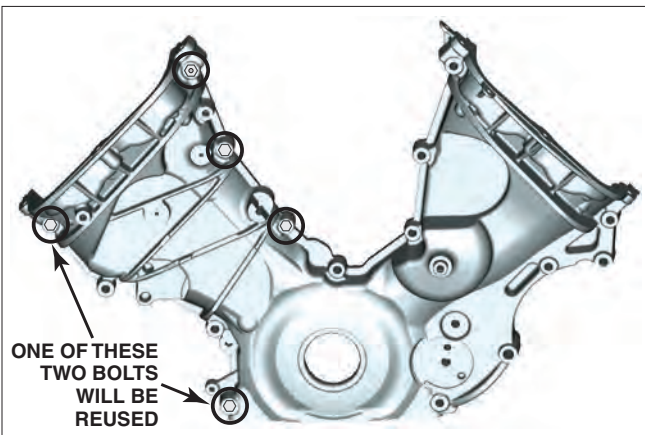

3. Install the water pump on the front cover and install the three (3) bolts only. Leave out the bolt at the 10 o'clock position. Torque the bolts to 25 Nm.

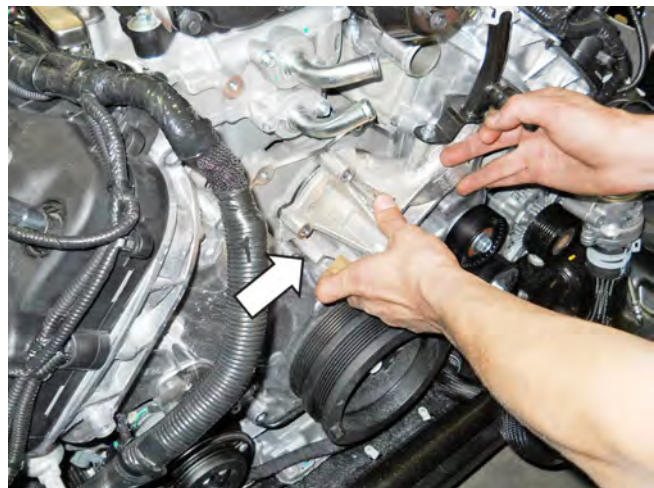

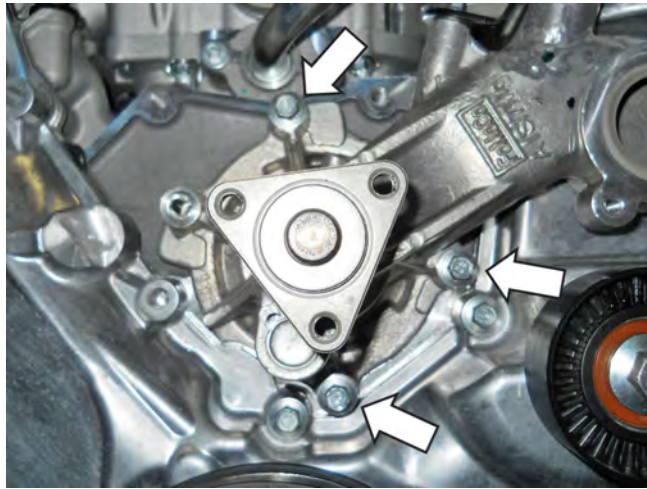

4. Install the thermostat housing and hose assembly and secure it with the clamp.



5. Install the two (2) thermostat housing mounting bolts and torque to 10 Nm.



6. Install the upper FEAD bracket (1314-8B653U) using one (1) M8x1.25x57 bolt (that was removed in the step 1 of this section), three (3) (black) M8x1.25x60 bolt (11116346) and two (2) M8x1.25x84 bolts (W704752) from Hardware Kit C (1315-TVSHKC). Torque bolts to 25 Nm.

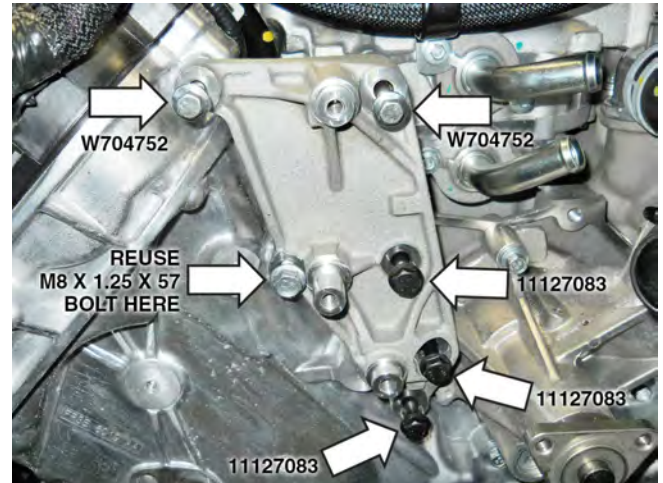

7. Install two (2) idler pulleys (953045) onto the machined posts of the upper FEAD bracket. Secure the pulleys using two (2) M8 x 1.25 x 28 mm idler bolts (R18020060) with washers found in Hardware Kit C (1315-TVHSKC). Torque bolts to 25 Nm (13 mm socket).

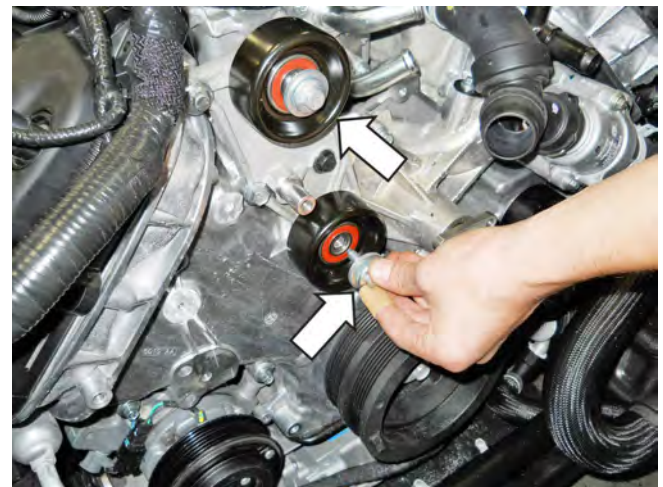

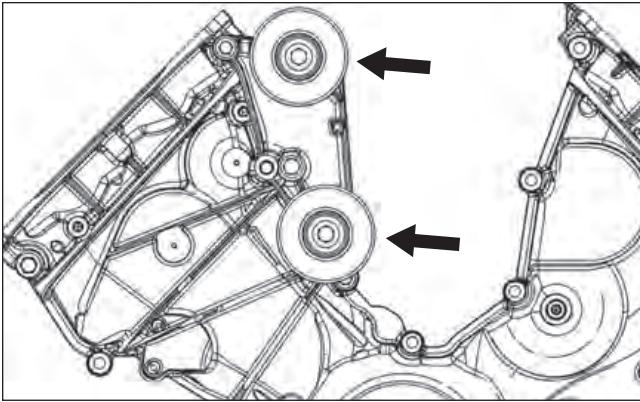

8. Route the FEAD belt (K060806) as shown. Do not route the belt onto the supercharger pulley.



9. Loosely install the FEAD tensioner bracket assembly (13118B603) onto the front cover using two (2) M8 x 1.25 x 120 mm bolts (N811329) found in Hardware Kit C (1315-TVSHKC).

NOTE: Install the lowest bolt into the casting prior to positioning in vehicle, in order to clear the sway bar.

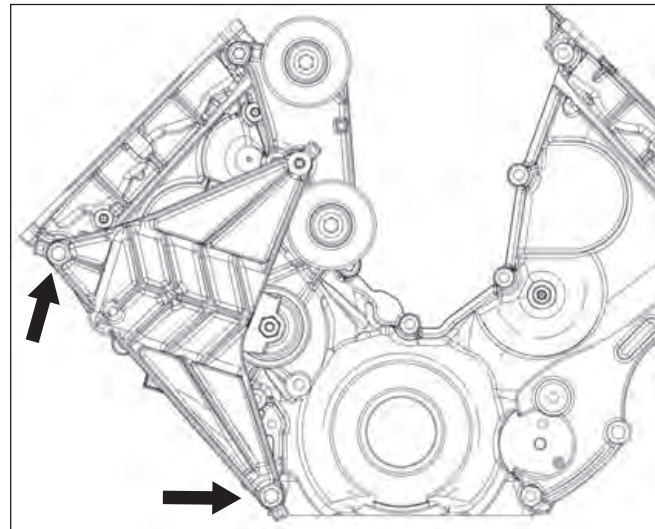
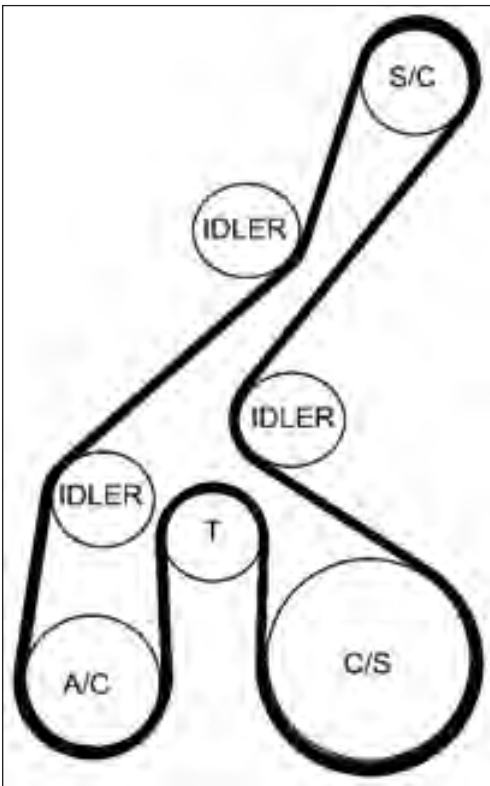



10. Install one (1) M8 x 1.25 x 41 mm bolt (W705128) found in Hardware Kit C (1315-TVSHKC), to fasten the tensioner bracket to the upper FEAD bracket. Torque all three (3) tensioner bracket bolts to 25 Nm.

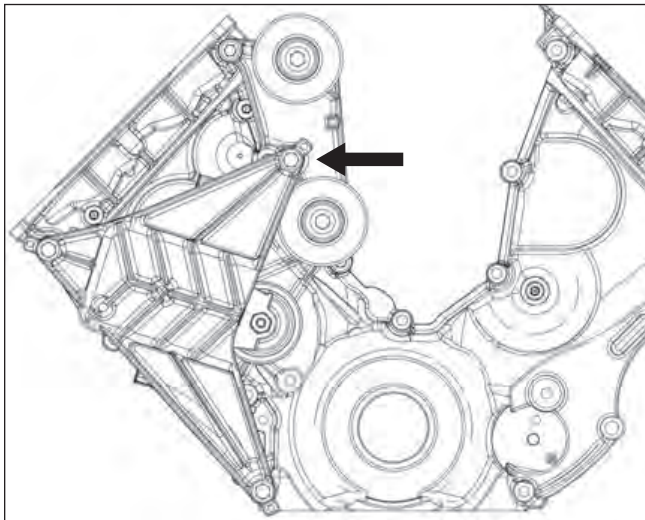

11. Using a 17 mm socket, rotate the new tensioner clockwise to install the belt on to the supercharger pulley. Inspect each pulley to ensure the belt is properly seated. Ensure all supercharger pulley bolts have been torqued to 10 Nm.

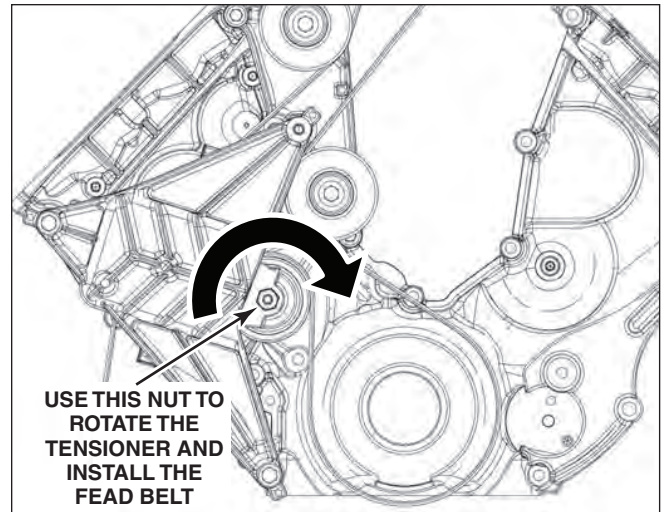

12. Re-install the water pump pulley using the three (3) removed bolts. Torque the bolts to 25 Nm.
13. Re-install the stock FEAD belt by rotating the tensioner counter-clockwise and routing the belt as per the stock Ford belt routing.

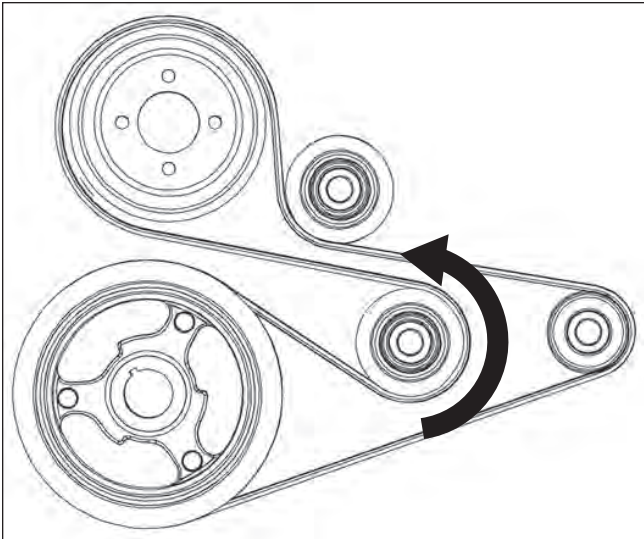

INTERCOOLER LOW TEMPERATURE RADIATOR (LTR) ASSEMBLY

1. Raise the vehicle.
2. If you have a performance pack car, remove the two (2) outboard bolts on the factory radiator support bracket (as viewed from below the vehicle).

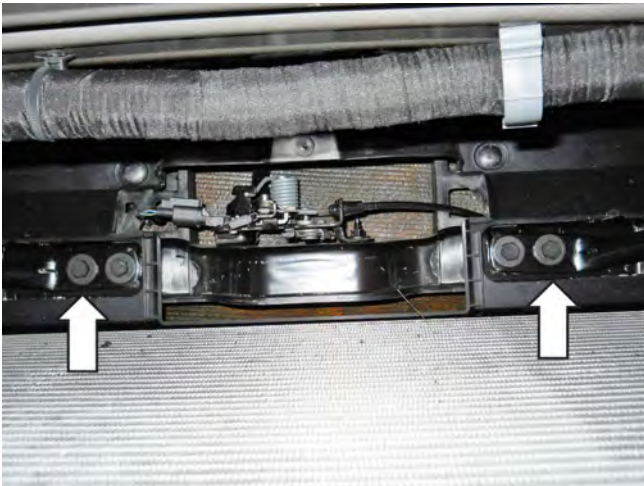

3. Install the low temperature radiator (LTR) assembly (1315-8K229) and secure the low temp radiator into position with the two M8 x 16 mm bolts included in hardware kit H.

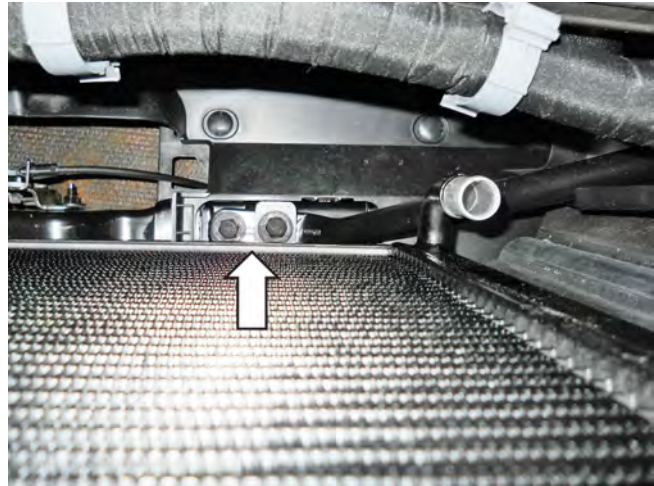

4. Install two (2) J-clips (W520823) on both frame rail ends as shown. Some trimming of the J-clip may be required to install the J-clip through the hole in the frame.

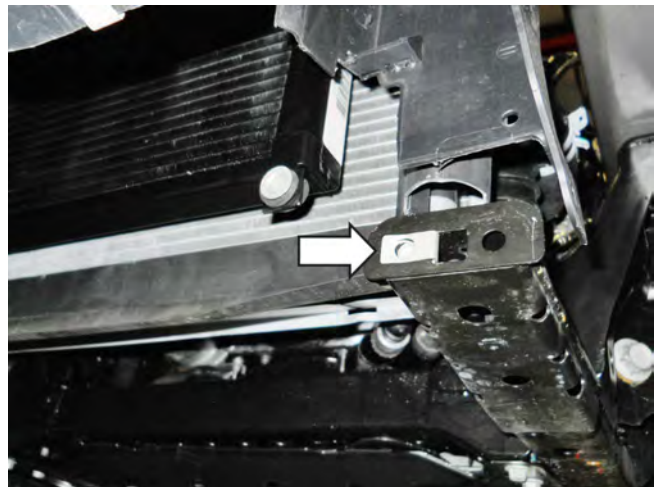

5. When viewing from the front of the vehicle install the Support Bracket (1315-8K245) on the right hand side and the Support Bracket (1315-8K244) on the left hand side. Secure each bracket at the radiator using a bolt (W705128) and nut (W520413). Secure each bracket to the chassis using a bolt (W705128) through the J-clip. Torque to 25 Nm.



RH bracket



LH bracket

6. Temporarily install the LTR outlet hose (1315-8D030) on the upper LH side of the LTR radiator and route it to the intake manifold. Mark the LH radiator close-out panel where the hose should pass through. Use snips to cut a notch in the close-out panels as required for the hose to pass through.



LTR outlet hose (1315-8D030)





7. Reinstall the hose onto the LTR outlet, and recheck the hose fit. Adjust as necessary until the hose passes through the close-out panel without being kinked.
8. Once a proper fit is obtained, ensure the close-out panel is secure in place.
9. Install the LTR outlet hose through the close-out panel to the intake manifold.
10. Install the hose onto the LTR outlet and secure it with the clamp (CT19X12) from Hardware Kit G (1315-TVSHKG).



11. Install the hose onto the intake manifold inlet and secure it with the clamp (CT19X12) from Hardware Kit G (1315-TVSHKG).

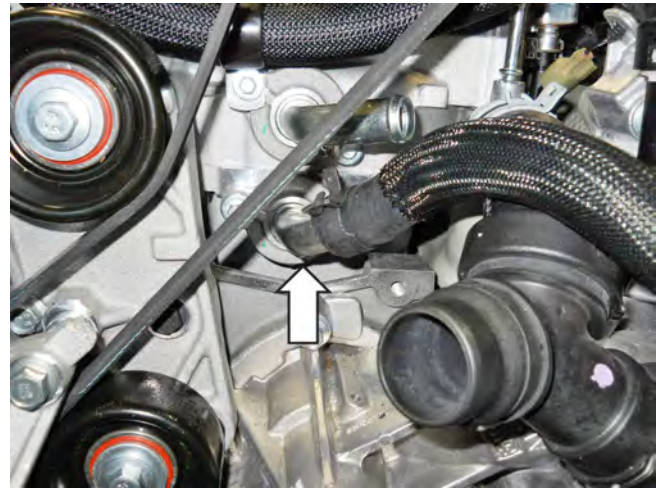

INTERCOOLER PUMP, MOUNTING BRACKET AND HOSES

1. Install two (2) intercooler pump brackets (1318-8C4192) (upper) over the frame as shown



2. Place the intercooler pump mounting bracket (1318-8C4191) (lower) in position under the upper brackets and install the six (6) bolts (161821)
3. Install the intercooler pump (FS00057975) onto bracket using the p clip (8863T95). Secure with 1 bolt (BCSM-08016S) Torque the bolt to 10 Nm.

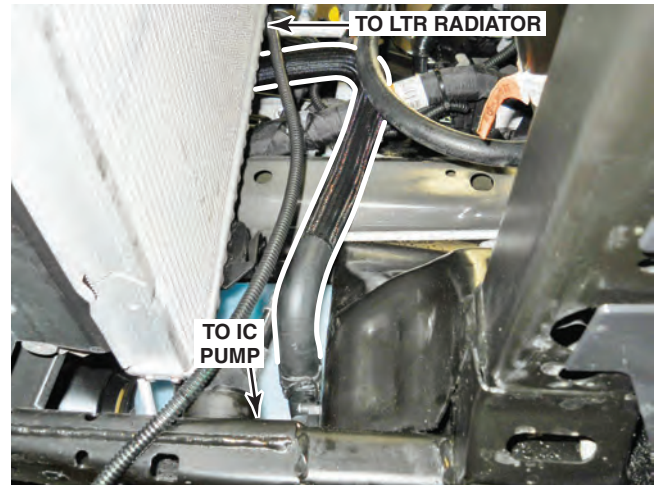

Pump hose outlet connection view

4. Install electrical jumper connector (PT00045528) between intercooler harness and pump as shown and plug into intercooler pump.



Intercooler pump outlet hose (1315-6K236)

5. Install the intercooler pump outlet hose (1315-8K236) from the pump outlet, over the side of the frame rail and to the inlet on the lower RH side of LTR.



Pump hose to LTR connection

- Secure the hose to the pump using one (1) clamp (CT19X12) from Hardware Kit G (1315-TVSHKG). Secure the hose to the LTR inlet using one (1) clamp (CT19X12) from Hardware Kit G (1315-TVSHKG).

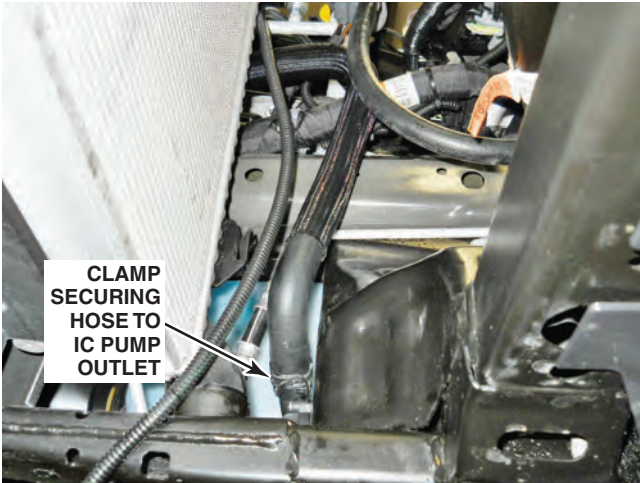

- Collect the excess intercooler pump harness and secure it with zip ties as needed.



NOTE: Route all intercooler hoses very carefully. It is critical for intercooler performance that these hoses are not kinked once installed into the vehicle.

ELECTRIC FAN, INTERCOOLER RESERVOIR AND HOSES

- Install the electric fan in position and secure it with the two (2) mounting bolts previously removed. Torque to 10 Nm.



- Connect the fan electrical connector.



Fan electrical connector

- Ensure that the Clip (20860) installed during the electric fan modification is in place at the bottom of the intercooler degas bottle (1315-8D080).



- Install the intercooler pump inlet hose (1315-8D029) to the bottom of the intercooler degas

bottle and secure it with the clamp (CT19X12).



pump inlet. Secure the hose using (1) clamp (CT19X12) from Hardware Kit G (1315-TVSHKG).

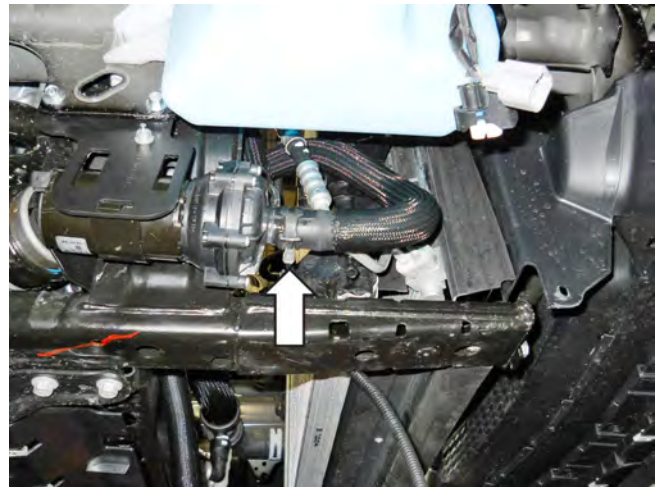

Intercooler pump inlet hose (1315-8D029)

5. Install the intercooler degas bottle with intercooler degas bottle cap (9C3Z-8101) onto the fan shroud J-clips. Push the bottle into position. The clip on the bottom should retain the degas bottle in place.
6. Install two (2) M6 x 1.0 x 22 mm mounting bolts (N605891) found in Hardware Kit H (1315-TVSHKH) and torque to 10 Nm.

8. Install the intercooler degas bottle inlet hose (1315-8D031) to the outlet on the intercooler.

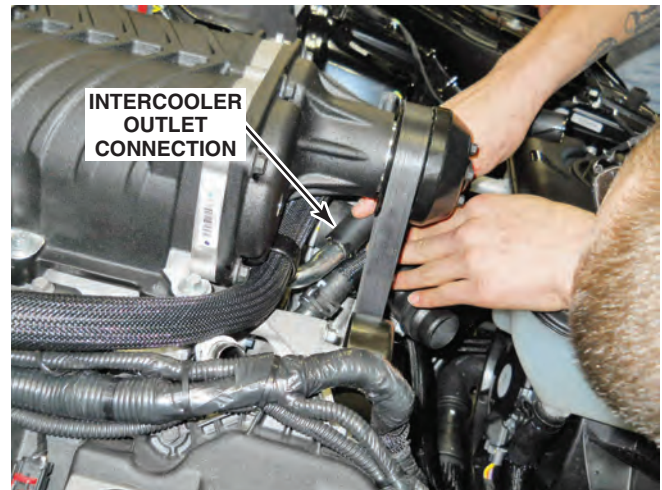

Outlet hose connection at top port of intercooler

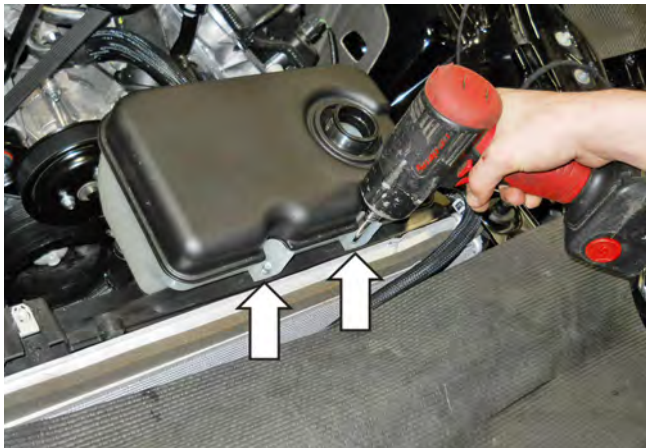

9. Install the hose to the intercooler degas bottle inlet using (1) clamp (CT19X12) from Hardware Kit G (1315-TVSHKG).

7. Install the hose (1315-8D029) from the bottom of the intercooler degas bottle to the intercooler



10. Install the hose to the intercooler cooler outlet using (1) clamp (CT19X12) from Hardware Kit G (1315-TVSHKG).



2. Reconnect the other end of the coolant hose to the upper RH inlet of the radiator. Secure it with the clamp.

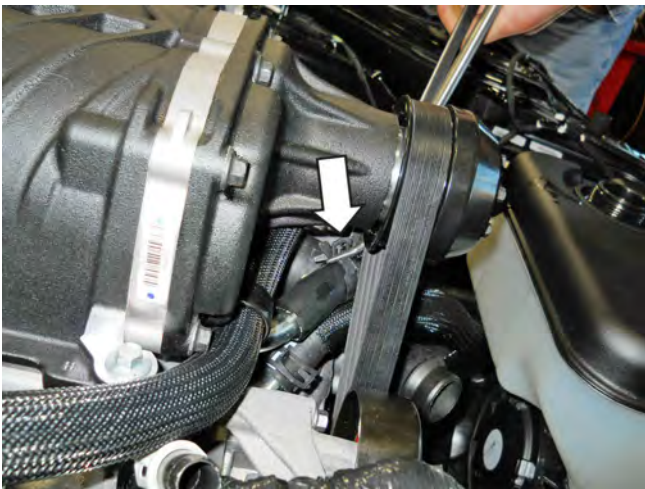

RADIATOR HOSES, ENGINE DEGAS BOTTLE AND HOSES

1. Reconnect the coolant hose to the outlet on thermostat housing.



3. Reinstall the factory degas bottle onto the fan shroud and torque the bolts to 10 Nm.



4. Install the engine degas bottle hose on the rear of the bottle and to the upper LH radiator. Secure both ends of the hose with the clamps.

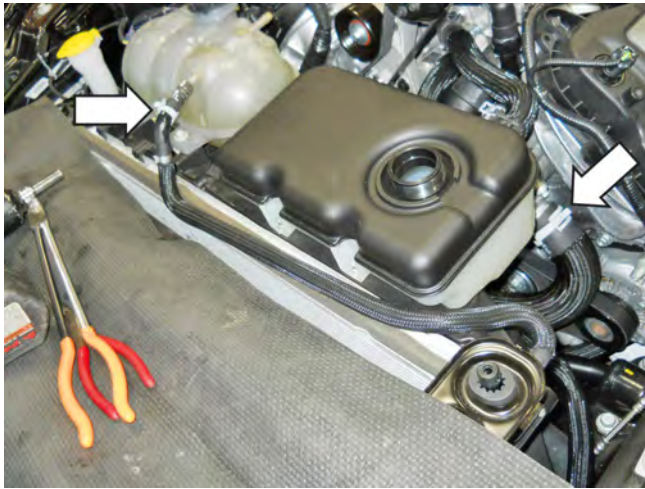

5. Transfer the hose clamp from the bottle end of the factory degas hose to new 3/8" engine degas hose (1315-8276). Install the hose clamp (62002) onto the other end of the engine degas hose.
6. Install the 3/8" engine bottle degas hose from the engine degas bottle to the fitting by the driver side cylinder head on the coolant outlet neck. Tighten worm gear clamp torque to 3 Nm.



7. Install the other end of the hose to the engine degas bottle as shown. Secure the constant tension clamp.



8. Ensure that all intercooler hoses, the degas hose and all clamps and wiring have been installed to provide maximum clearance to the supercharger belt.

AIR INDUCTION SYSTEM

1. Remove the old MAF wire harness clip christmas tree that retained the harness to the body.



2. Install the dirty air duct (1315-9F763) at the LH side of the radiator.



3. Lower the airbox assembly into mounting position. Align the airbox assembly opening with the dirty air duct and press it into the dirty air tube until properly installed. A snap will be heard when properly seated.



5. Install the clean air tube (1315-9R504) in the vehicle using two (2) hose clamps (R07130015) from Hardware Kit A (1315-TVSHKA). Torque clamps to 3 Nm.



4. Secure the airbox using the M6 bolt from the original airbox and torque to 10 Nm.





6. Install the PCV fresh air inlet tube (1315-6758) by connecting the 90-degree fitting to the driver side cam cover and angled fitting to the PCV fitting in the clean air tube.

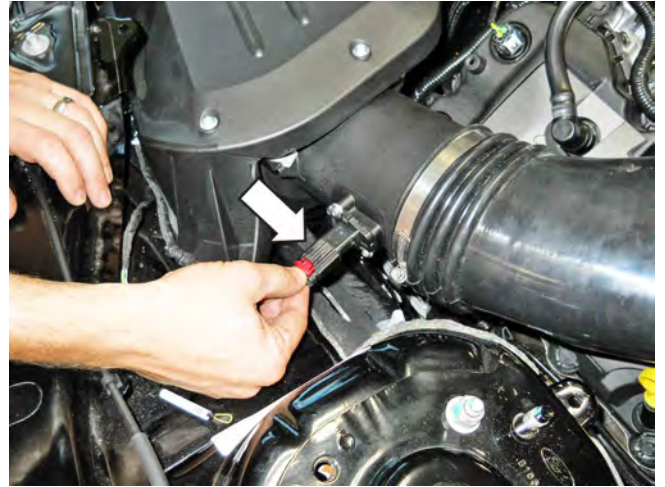

8. Connect the open end of the supercharger bypass reference line (7R3V-9E498) to the fitting on the clean air tube.



7. Route the MAF wire harness around the airbox assembly and connect the harness to the MAF sensor. Make sure the red lock is engaged on the connector.

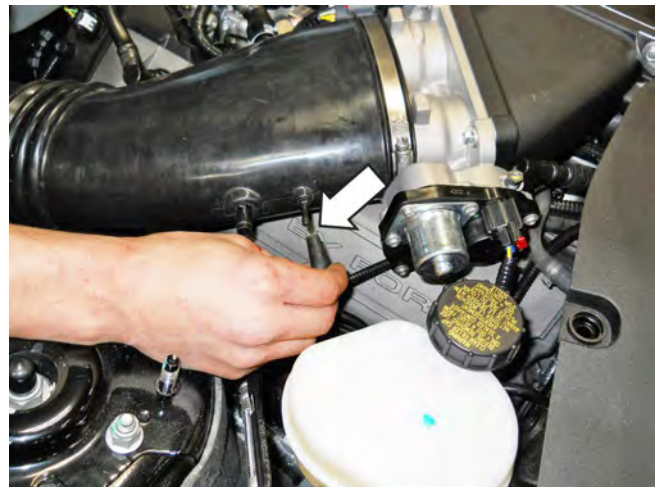

9. Connect the brake aspirator hose assembly (hose 3) to the fitting on the clean air tube.



K-BRACE

1. Once the supercharger installation process is complete, lift up the cowl trim panel and slide the modified K-brace underneath. Reinstall the K-brace over the studs and into position on the vehicle.



2. Install the nuts on the studs and torque to 25 Nm using a 15 mm socket.
3. Install the five (5) mounting bolts and torque to 25 Nm using a 13 mm socket.
4. Reinstall the six (6) pushpin retainers on the cowl trim panel.

SECTION E – FINAL ASSEMBLY

1. Fill the engine cooling system (using a proper coolant mixture) to the marked level on the radiator degas bottle.
2. Using the same coolant mixture, fill the intercooler system. The coolant should be approximately one inch below the top of the cap.

IMPORTANT: Both coolant systems can trap a large amount of air. It is very important to verify that the air is purged and that coolant is flowing properly through both systems. ROUSH recommends vacuum filling both systems to properly evacuate the trapped air.

3. Reinstall lower close-out panel and inner fenders by reversing the removal procedures.
4. Reinstall the front wheels/tires. Torque wheel lugs to the factory Ford specifications.
5. Inspect all underhood wiring harnesses for potential interference issues. Use zip ties to safely position the harness away from any areas of concern.
6. Reinstall the radiator trim cover by reversing the removal instructions.
7. If the PCM was removed and shipped to ROUSH for a ROUSH performed flash, reinstall it once the PCM is returned from ROUSH. If you are equipped with a SAE J2534 pass through device, refer to the PCM Flashing instructions found on our website when the installation is complete.
DO NOT ATTEMPT TO REINSTALL THE PCM AND START THE VEHICLE IF THE PCM IS NOT EQUIPPED WITH A ROUSH CALIBRATION. OPERATING THE ENGINE WITHOUT THE RECALIBRATED PCM WILL RESULT IN ENGINE DAMAGE OR FAILURE AND WILL VOID THE WARRANTY.
8. Reinstall the battery connections by connecting the positive cable first then connecting the negative cable. Reinstall the battery cover panel with pushpins.
9. Reconnect the fuel pump control module electrical connector located under the backseat on the driver side.
10. Place the belt routing diagram (13116E072) found in Hardware Kit F (1315-TVSHKF) on the underside of the hood, on the driver side, opposite of the factory vehicle emission control information decal.

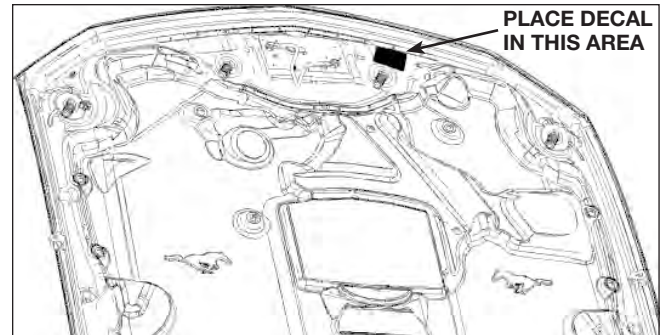

11. Place the PCM decal (R07100008) found in Hardware Kit F (1315-TVSHKF) in a visible location.
12. Place the "PREMIUM FUEL ONLY" Decal (13109A095) (white decal with black lettering) found in Hardware Kit F (1315-TVSHKF) on the arm door of the fuel filler door as shown.



13. Place the "PREMIUM FUEL" (R07110004) Clear Decal with white lettering on the instrument cluster bezel, on the flat area below the small center gauges as shown.

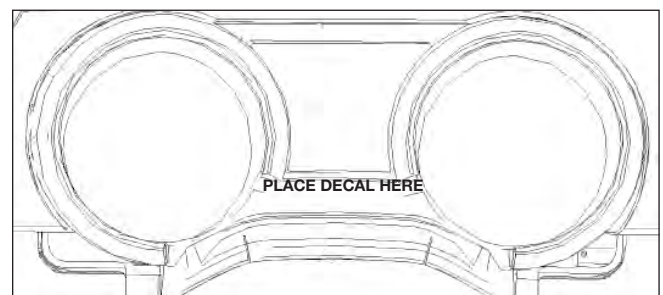

14. **If performing the PCM Flash procedure, proceed to the “PCM Flashing” section. If the PCM was sent to ROUSH for the Optional ROUSH Performed Flash and it has been reinstalled,** start the engine and check for unusual noise, dash service lights, and/or unusual operation. If problems are detected, immediately stop the engine or vehicle, diagnose and repair the problem.

PCM FLASHING

1. If equipped with a SAE J2534 pass through device, refer to the RDT-CALIM manual found on our website. The RDT-CALIM manual will guide you through the ROUSH Diagnostic Tool (RDT) software installation process and the ROUSH PCM flashing procedure. **OPERATING THE ENGINE WITHOUT THE RECALIBRATED PCM WILL RESULT IN ENGINE DAMAGE OR FAILURE AND WILL VOID THE WARRANTY.**

NOTE: Make sure to skip the ICM flash step as detailed in RDT-CALIM.

2. Once the PCM has been successfully recalibrated, start the engine and check for unusual noises, dash service lights, and unusual operation. If problems are detected, immediately stop the engine or vehicle, diagnose and repair the problem..