



2018+ Roush Supercharged Mustang Max Cooling Upgrade

P/N: 422270 (1320-COOLKIT)

Application: 2018-2021 Mustang 5.0L w/ Roush Supercharger
2018-2019: Roush Stage 3 Mustang

Installation Instructions

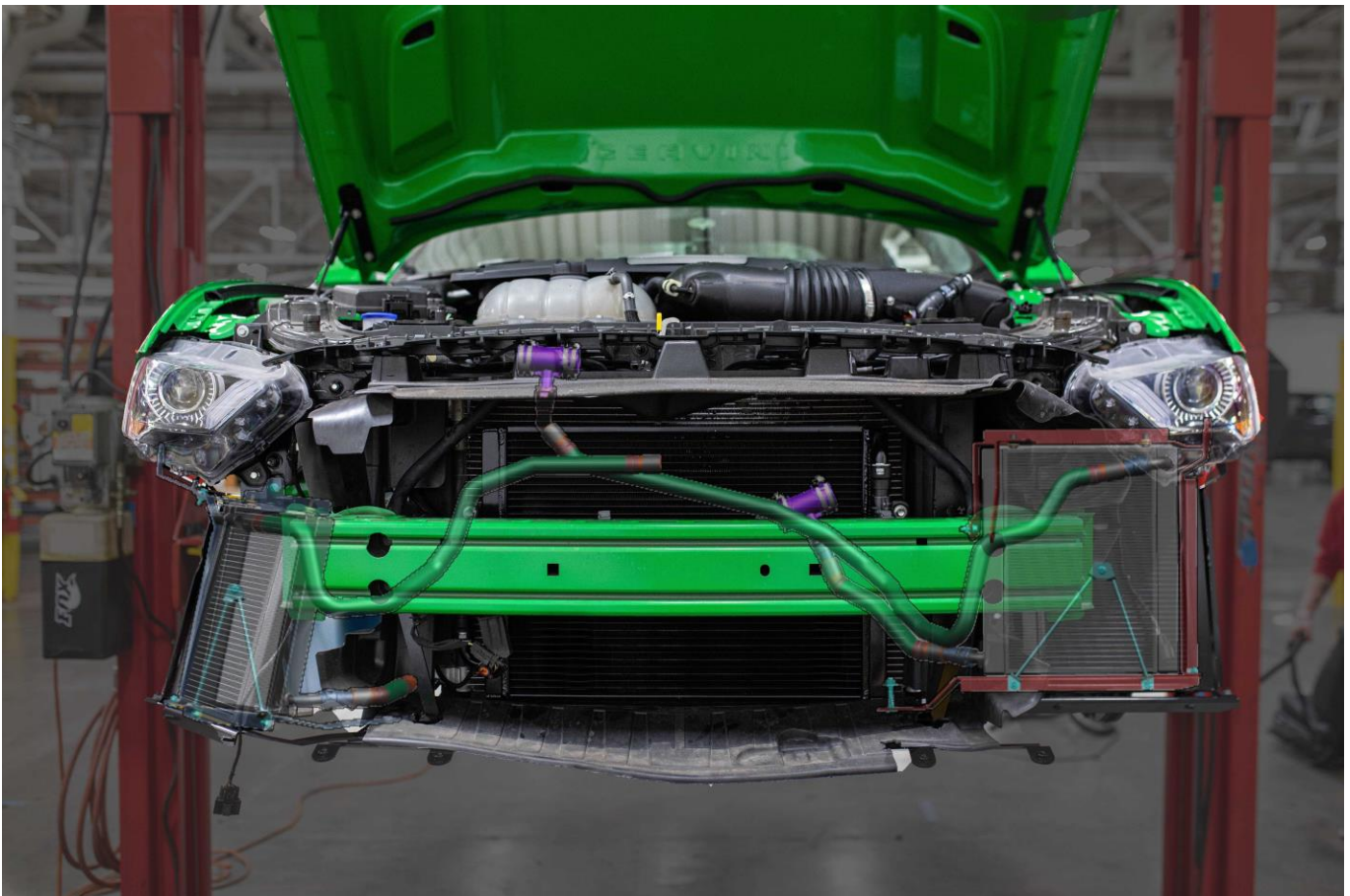

Before installing your ROUSH Performance Product(s), read through the entire installation procedure and check to make sure all items are present. Contact ROUSH Customer Service at 1-800-59-ROUSH, weekdays from 9:00 AM to 5:00 PM EST, with any questions regarding fit, missing parts or instructions that are unclear to you.



ROUSH
P E R F O R M A N C E

422270 (1320-COOLKIT-AA) Contents

Description	Part Number	Qty
KIT 1 AUX COOLING	1320-COOLKIT1-AA	1
AUX ENG COOLER BRACKET TOP LH	1320-8D051-AB	1
AUX ENG COOLER BRACKET LOWER LH	1320-8D053-AB	1
AUX ENG COOLER BRACKET MID LH	1320-8D055-AB	1
PENCIL BRACE LH	1320-8D041-AB	1
HOSE ENG LOWER TO AUX COOLER	1320-18K497-AA	1
PENCIL BRACE RH	1320-8D040-AB	1
AUX LTR BRACKET TOP RH	1320-8D050-AB	1
AUX LTR BRACKET BOTTOM RH	1320-8D052-AB	1
AUX LTR BRACKET MID RH	1320-8D054-AB	1
HOSE AUX LTR TO LTR ASY	1320-18K498-AA	1
HARDWARE KIT – COOLING COMPONENTS	1320-COOLHDWK1-AA	1
M8X1.25X16 BOLT	161821	1
RUBBER GROMMET - LTR	0709116	1
J CLIP M6	N623332-S439	1
M6X1X20 BOLT	BM6X100X20HF-S437	2
M8 WASHER	38404	1
M8 HEX NUT	153639	1
POWER GRIP CLAMP 3/4"	32929	2
POWER GRIP CLAMP 1 3/4"	32954	4
GROMMET	R07060107-13-AA	1

Description	Part Number	Qty
FOAM – WATER PUMP / RESERVOIR MOUNT	1318-8D082-AA	6
RADIATOR T	1320-18K323-AA	2
M6X1X16 HEX FLANGE BLACK BOLT	W500013-S307	2
M6X1 NUT	W520412-S437	9
KIT 2 BODY COMPONENTS	1320-COOLKIT2-AA	1
CORNER POCKET LH	1320-17B973-AA	1
CORNER POCKET RH	1320-17B974-AA	1
FENDER EXTRACTOR LH	1320-16C803-AA	1
FENDER EXTRACTOR RH	1320-16C804-AA	1
FENDER EXTRACTOR CLOSEOUT LH	1320-17D625-AA	1
FENDER EXTRACTOR CLOSEOUT RH	1320-17D626-AA	1
HARDWARE KIT – BODY COMPONENTS	1320-COOLHDWK2-AA	1
FOAM TAPE	1320-CPFOAM-AA	2
TWO SIDED TAPE	TAPE-5390-25X204	2
STUD 6-32 – 1-1/4"	25112	12
NUT 6-32 HEX FLANGE	37332	12
PUSH NUT M6 X 1	0162872	12
SPRING CLIP	68920-177	6
HOSE AUX LTR TO RES	1320-18N3261-AA	1
AUX LOW TEMP RADIATOR	1320-8D048-AA	1
HOSE ENGINE UPPER TO AUX COOLER	1320-18N325-AA	1
AUX ENGINE COOLER	1320-8D049-AA	1

SYSTEM DIAGRAM

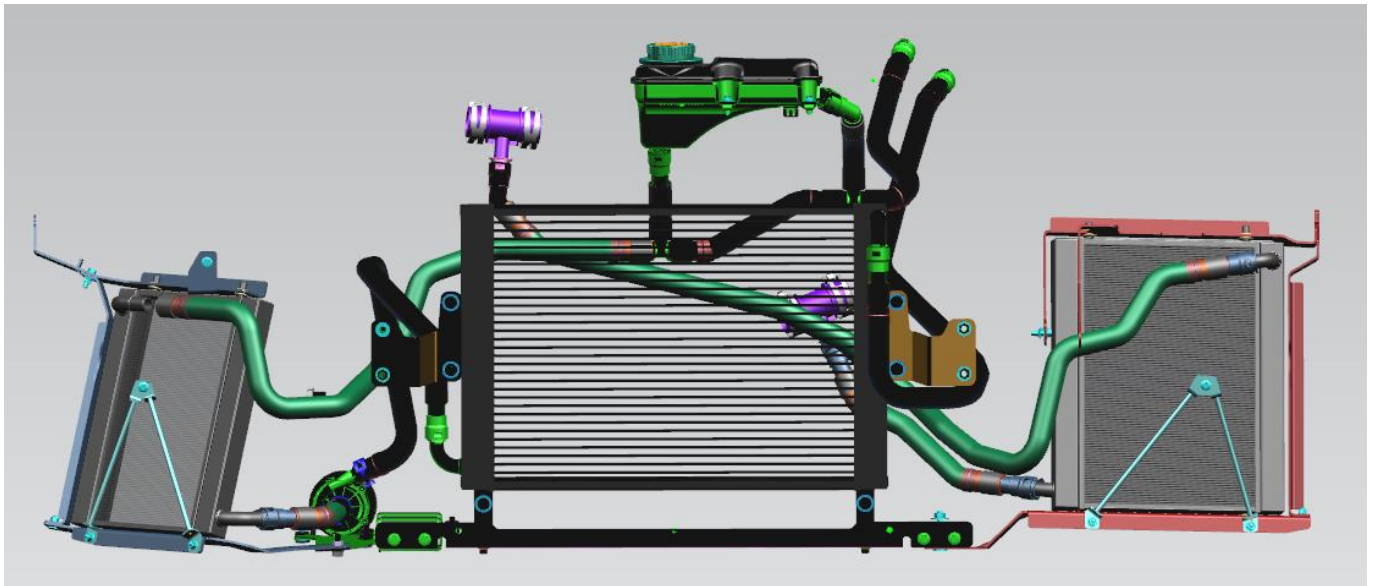

AUX
SUPERCHARGER
LTR

AUX ENGINE
COOLER

EQUIPMENT AND SUPPLIES REQUIRED

- Metric Socket Set (deep and shallow)
- Dremel or other rotary cutting tool
- Painters Tape
- Permanent Marker
- Trim Removal Tool
- General automotive tools (pliers, needle nose, etc)
- 5/16" Drill Bit
- Heat gun
- ½" Hole Saw/Drill Bit

LIMIT OF LIABILITY STATEMENT

The information contained in this publication was accurate and in effect at the time the publication was approved for printing and is subject to change without notice or liability. ROUSH Performance Products (RPP) reserves the right to revise the information presented herein or to discontinue the production of parts described at any time.

SAFETY REQUIREMENTS

STOP! READ IMPORTANT SAFETY CAUTIONS AND WARNINGS BEFORE PROCEEDING.

IMPORTANT SAFETY NOTICE

Appropriate disassembly, assembly methods and procedures are essential to ensure the personal safety of the individual performing the kit installation. Improper installation due to the failure to correctly follow these instructions could cause personal injury or death. Read each step of the installation manual carefully before starting the actual installation.

1. Always wear safety glasses for eye protection.
2. Place ignition switch in the OFF position.
3. Always apply the parking brake when working on a vehicle.
4. Chock the front and rear tires to prevent unexpected vehicle movement.
5. If working without a lift, always consult vehicle manual for correct lifting specifications.
6. Operate the engine only in well-ventilated areas to avoid exposure to carbon monoxide.
7. Do not smoke or use flammable items near or around the fuel system.
8. Use chemicals and cleaners in well-ventilated areas.
9. Batteries produce explosive gases, which can cause personal injury. Therefore, do not allow flames, sparks or flammable substances to come near the battery.
10. Keeps hands and any other objects away from the radiator fan blades.
11. Keep yourself and your clothing away from moving parts when the engine is running.
12. Do not wear loose clothing or jewelry that can get caught in rotating parts or scratch surface finishes.
13. Allow the engine, cooling system, brakes and exhaust to cool before working on a vehicle.

WORK SAFELY!

Perform this installation on a good clean level surface for maximum safety and with the engine turned off.

SECTION A – REMOVAL

The following section will guide you through the disassembly of the stock components. Special care should be taken to label fasteners and parts that are taken off during this procedure since many will be reused:

1. Cover both fenders with fender covers to protect the vehicle finish
2. Disconnect the battery ground cable.
3. Remove the nineteen (19) lower close-out panel bolts and the six (6) push pins. Remove the lower close-out panel from the vehicle (7 mm socket).
5. On both sides of the car, remove the fender liners

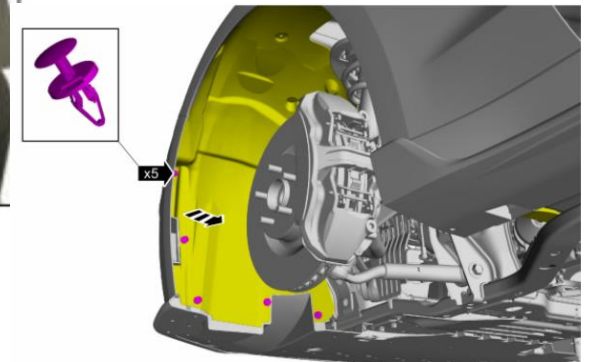
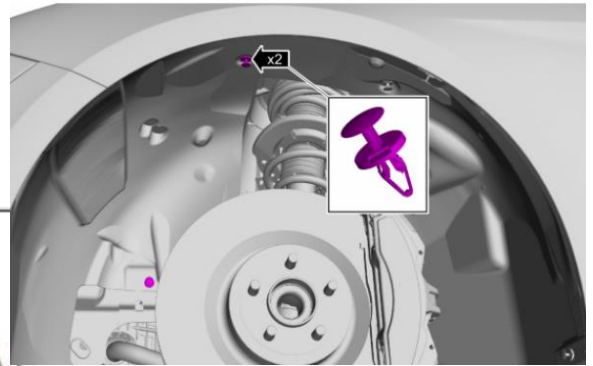

4. Remove the 8 radiator close out panel clips. Remove the close out panel.

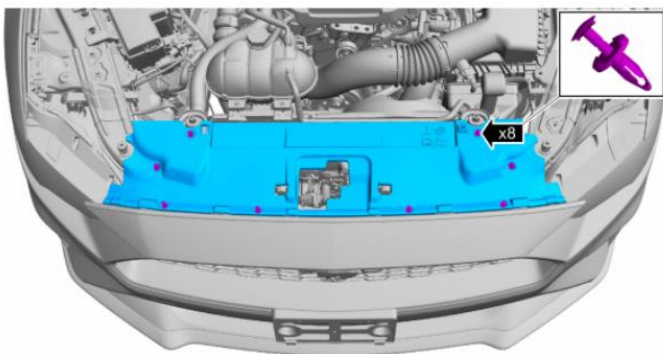

6. Remove the Front Bumper cover bolts, and remove front bumper cover, be sure to disconnect the turn signals

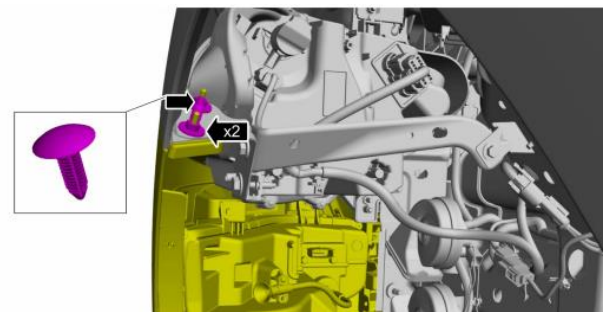

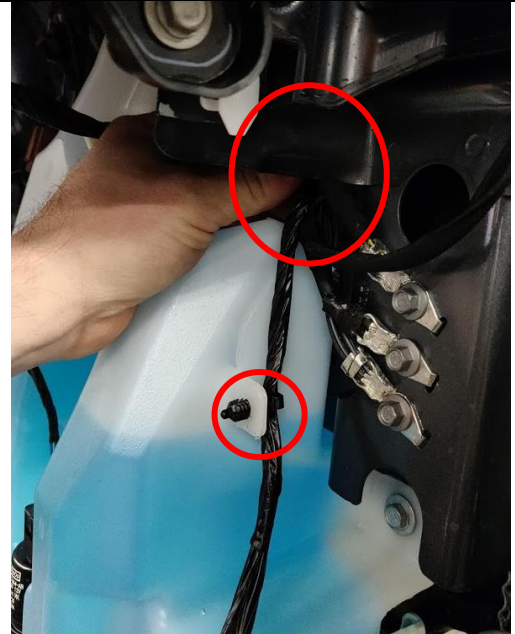
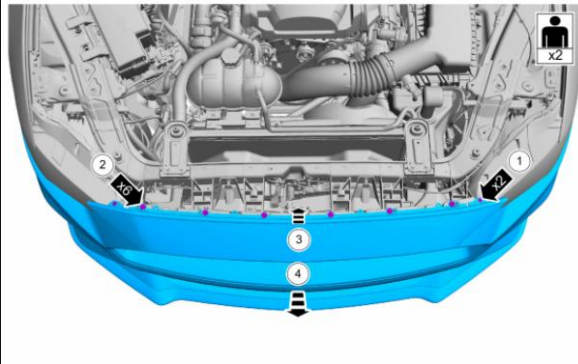

7. With the engine cool, remove the cap on the engine coolant degas bottle and drain the coolant using the petcock located on the lower passenger side of the radiator. Save the coolant for reuse. Drain Supercharger Coolant at this time too.

8. On the passenger side, locate the wire clip on the windshield bottle. Remove and flip wire harness on other side of clip. Tuck wires behind washer bottle.

9. On the driver's side, remove the horn bracket assembly and remove horns, discard the bracket but keep the nuts that were removed.

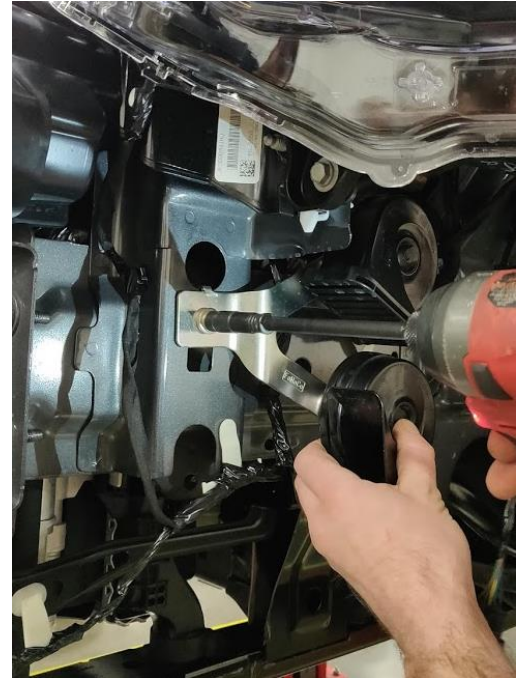
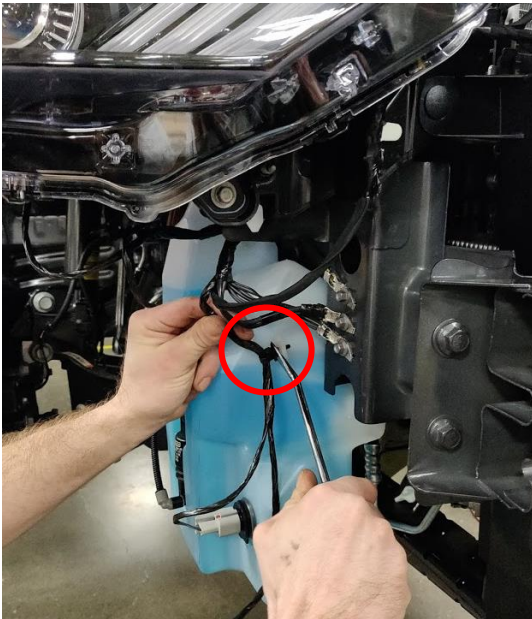



10. Remove the headlight mounting bolt on the passenger side, discard.

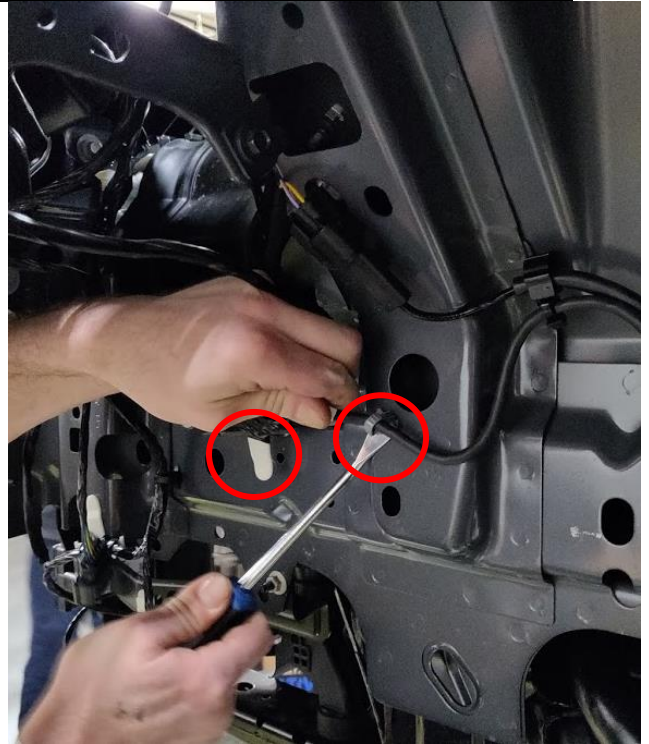

11. Unclip the two (2) wire harnesses in the driver side wheel well and tuck behind inner fender structure.





12. Place J clip (N623332-S439) on driver side frame rail and mark location with a center punch, drill a 1/4" hole.

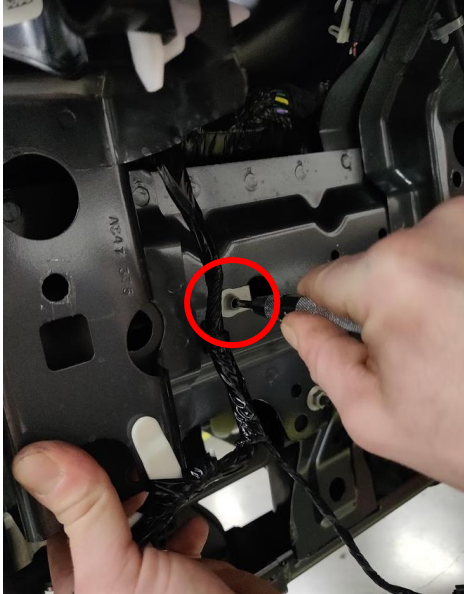

13. Flip J clip around and place on frame. This will be used at a later step



14. Remove the two bolts holding the headlight in place. Do not discard

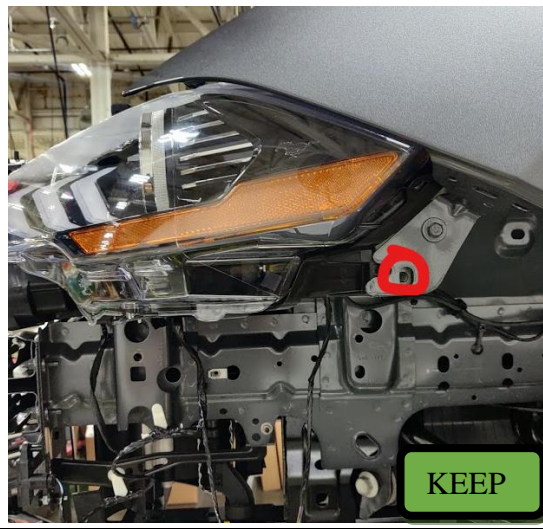
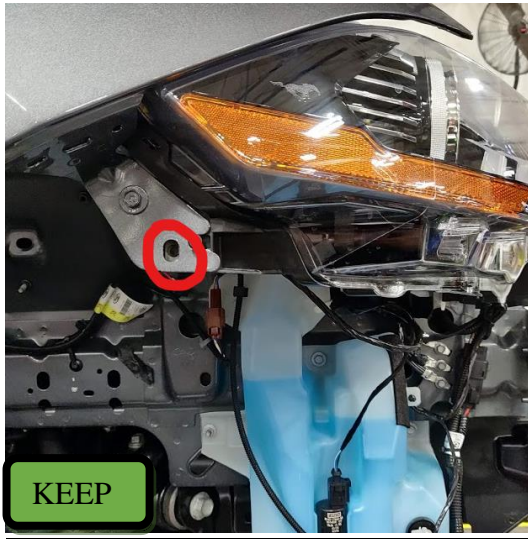



15. Remove intercooler coolant reservoir on passenger side of car by removing the two 13 mm bolts on the bottom of the bottle. And then unclamp the constant tension clamp. Discard bottle it will not be reused.

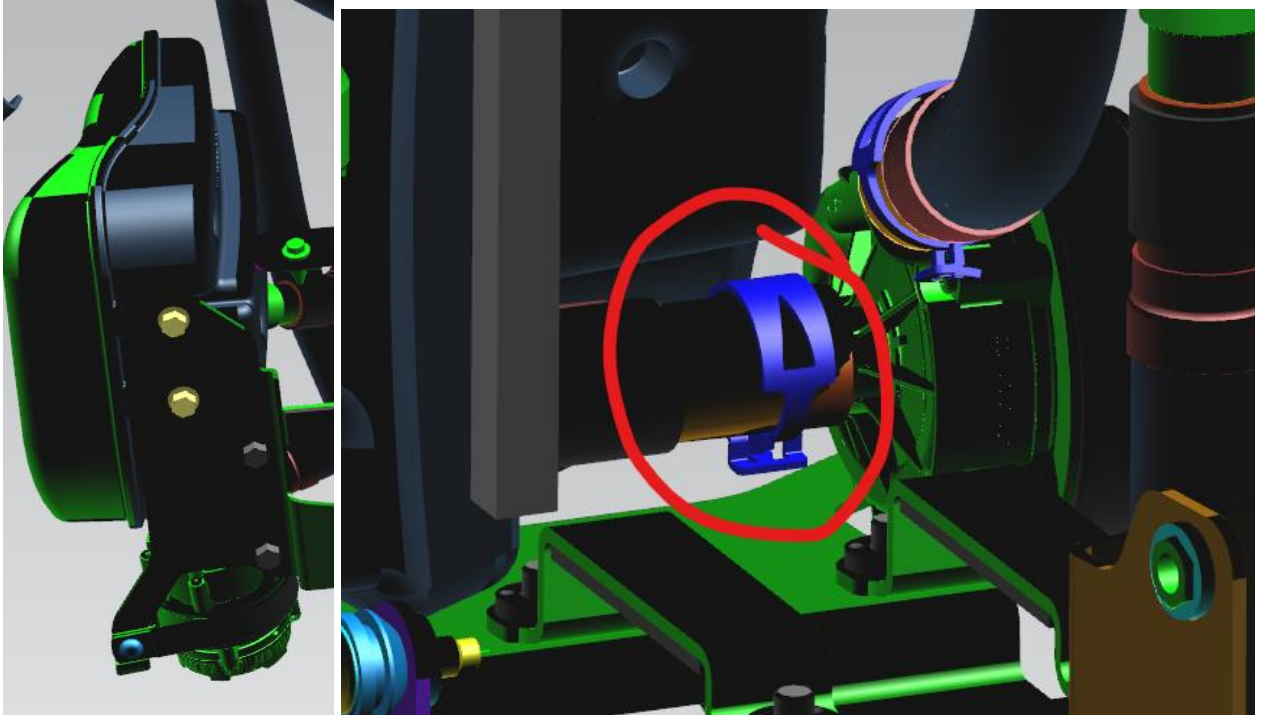

SECTION B – INSTALLATION

1. Locate brackets, and sub assemble the grommets on brackets first, and then hardware onto the brackets as shown. Do not torque fasteners until final install on vehicle. It helps to lubricate the grommets for installation ease using alcohol spray.

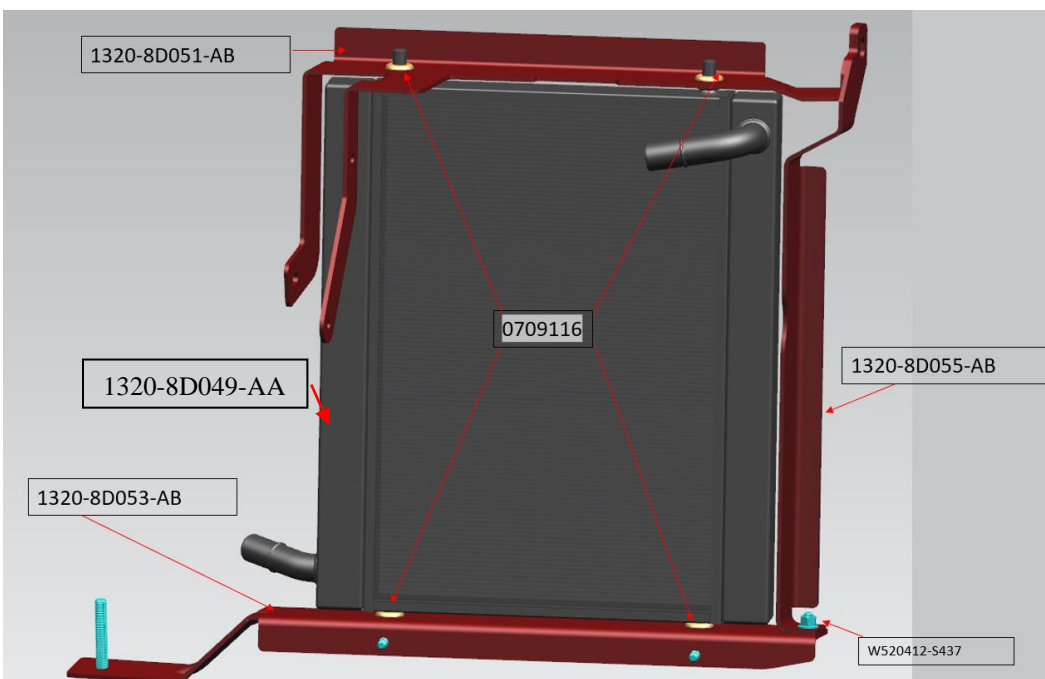
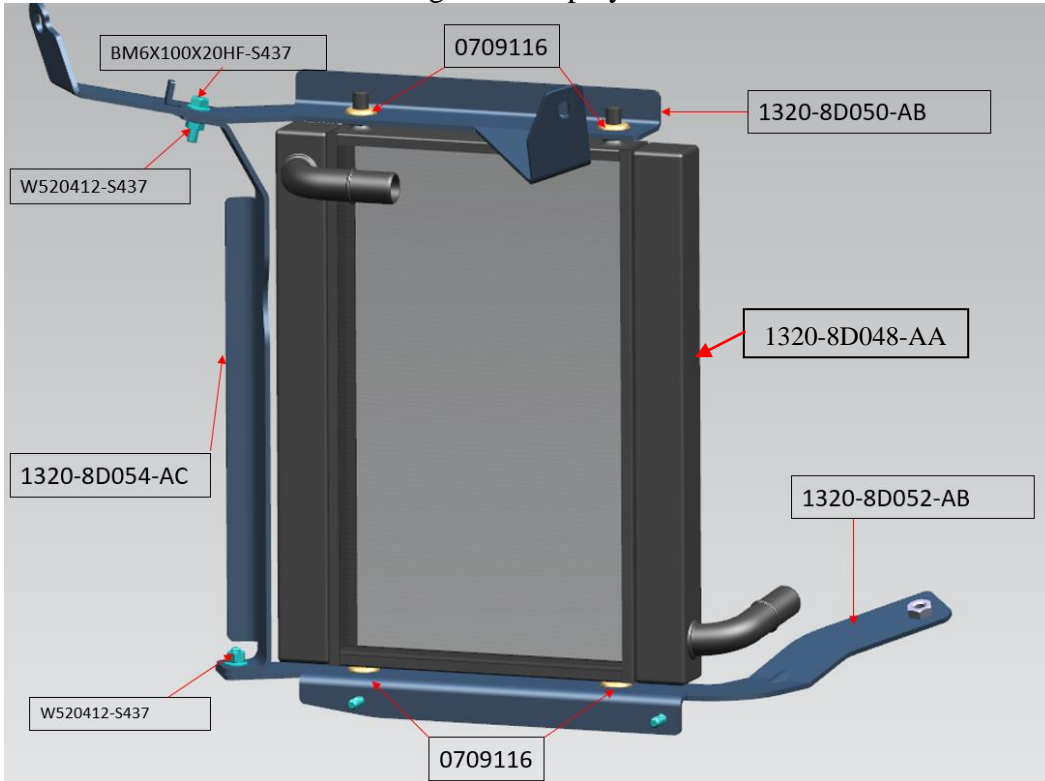

2. Install Horns onto the new bracket using the two nuts removed, note the orientation of horns



3. Install (1318-8D082 qty. 1) foam on Washer bottle



4. Install Passenger side cooler (1320-8D048-AA), reinstall bolts removed during disassembly for headlight. Torque bolts as shown below.

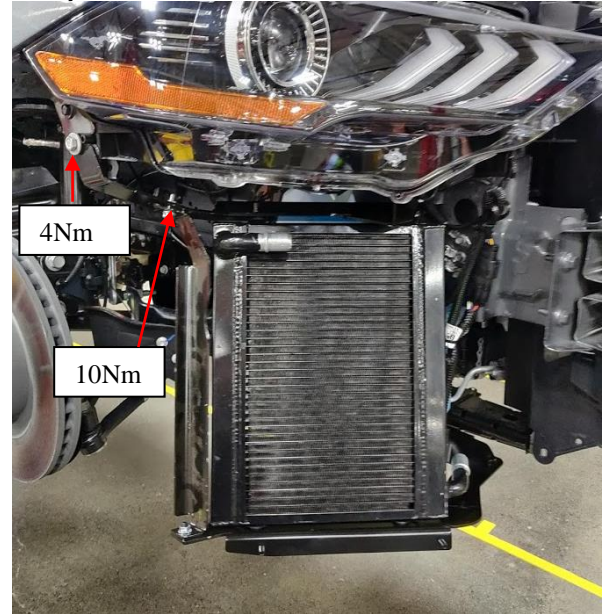

5. Install new headlight bolt and nut.
Bolt: (w500013-S307)
Nut: (W520412-S437)

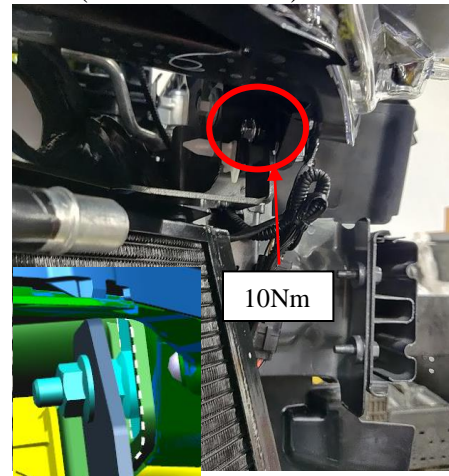

6. Install another piece of foam (1318-8D082) on cooler back to protect radiator from connector edge.



7. Install (161821qty 1) bolt onto intercooler pump bracket and torque to 10Nm

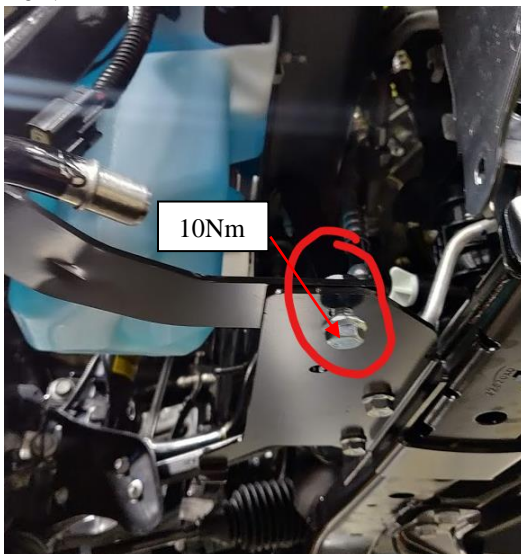

8. Install Driver side Aux Cooler (1320-8D049-AA) by fastening using the headlight bolt removed previously and torque lower bracket.

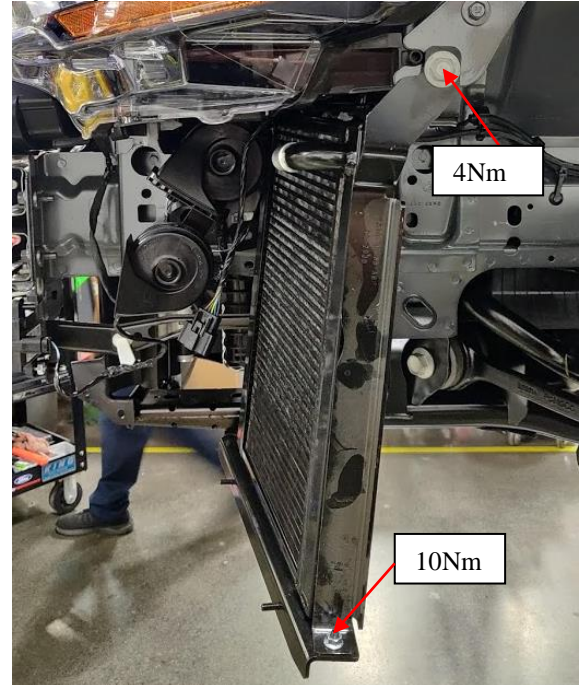

9. Install (BM6X100X20HF-S437) onto bracket, through the j clip installed previously. Torque to 10Nm, Orient horns as shown and tighten horn nuts to 8Nm

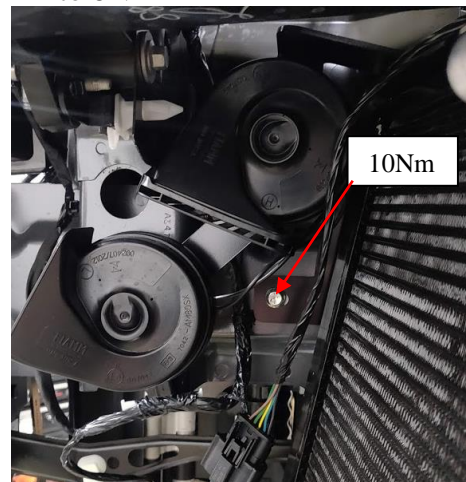

10. Install washer and nut onto lower bracket through frame, torque to 10Nm

Washer: 1140357 qty 1

Nut: 153639 qty 1

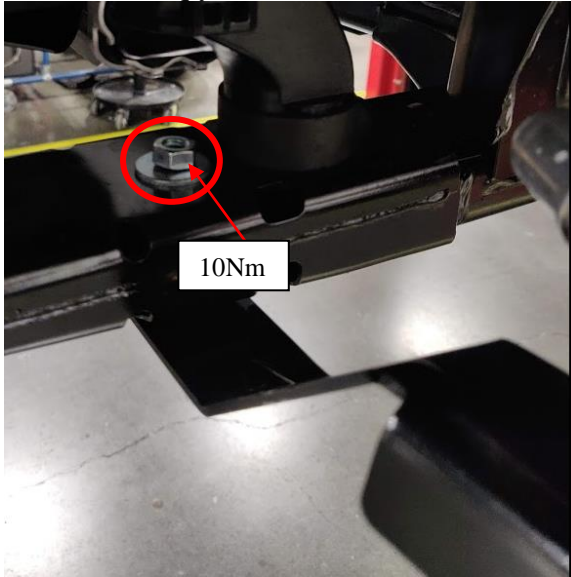

11. Install lower Rad hose 1320-18K497-AA on quick connect, route through engine bay as shown



12. Cut intercooler hose removed previously here, Remove Quick connect to be used in the next step, and discard the hose.

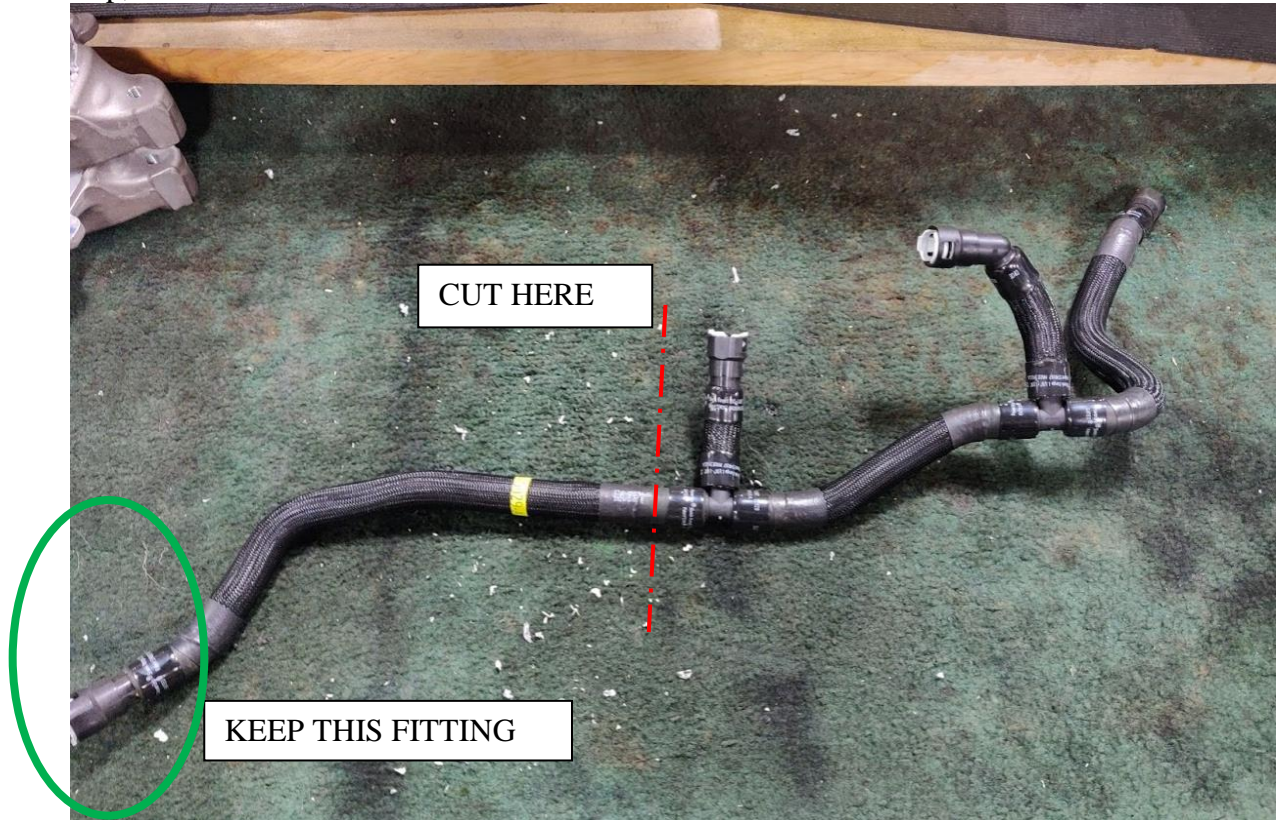

13. Install quick connect onto hose 1320-18N3261-AA using qty 1 power grip clamp 32929. Heat up power grip until snug.



14. Orient Hose as shown and install qty 1 power grip clamp (32929) on hose end. It helps to test fit hose prior to heating up clamp for proper routing.

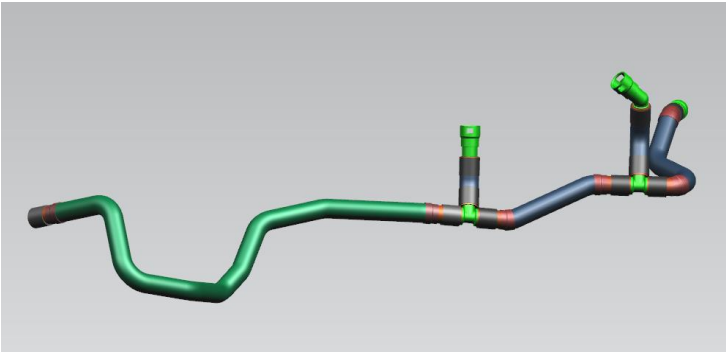

16. Install Hose onto driver side cooler (1320-18N325-AA), top connection, and route as shown.



15. Install new hose assembly made in previous step on passenger side cooler, top port as shown.



17. Drill qty 32 1/2" holes on back side of wheel liner, located behind the aux coolers. Orientation as shown (printable template at end of install instructions) Repeat for passenger side **DO THIS OFF OF VEHICLE!**



18. On Front fascia, use the template available online at Roushperformance.com to cut the bumper cover
(Perform this operation to both sides of vehicle)

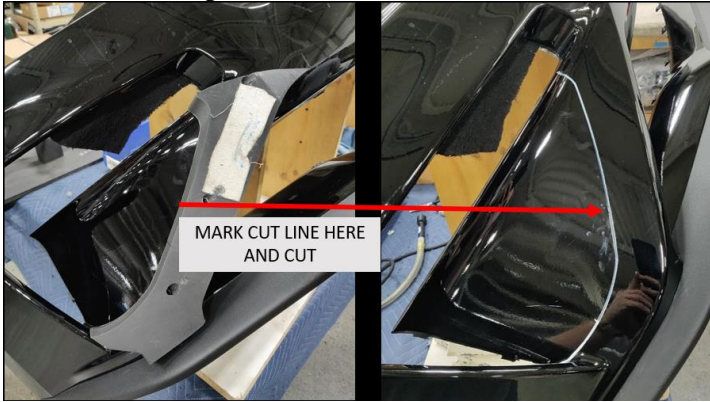

19. On front fascia, drill out turn signal lamp mounting holes to 1/4" using a drill bit. Repeat on Driver Side lamp



20. Install Pencil braces onto front fascia torque to 5 NM using:
Bolt PN: W500013-S307
Nut PN: W520412-S437
Driver side PN: 1320-8D040-AB
Passenger Side PN:1320-8D041-AB

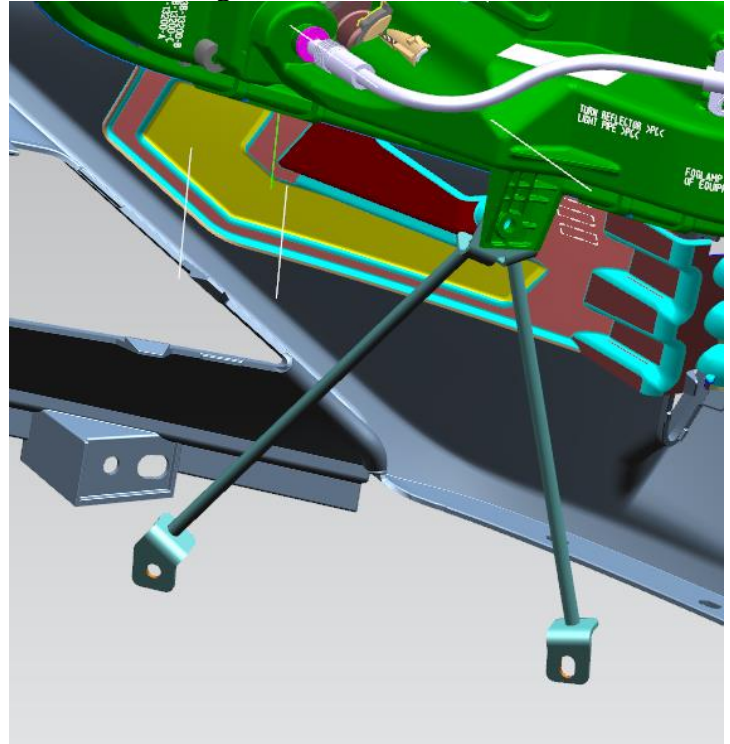

21. Install Front Fascia and align lower pencil brackets, use qty 2 m6 (W520412-S437) nuts per side and torque to 10 Nm

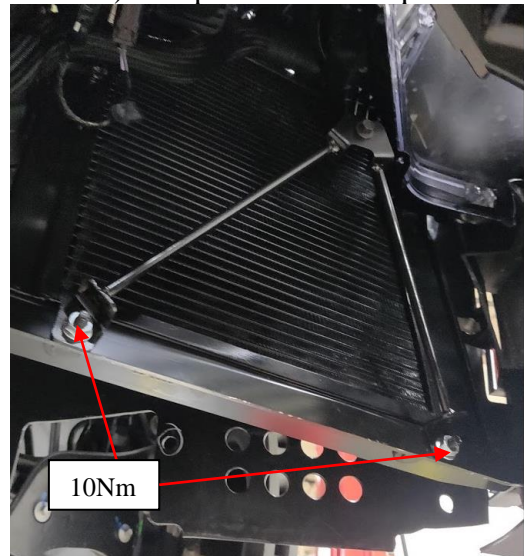

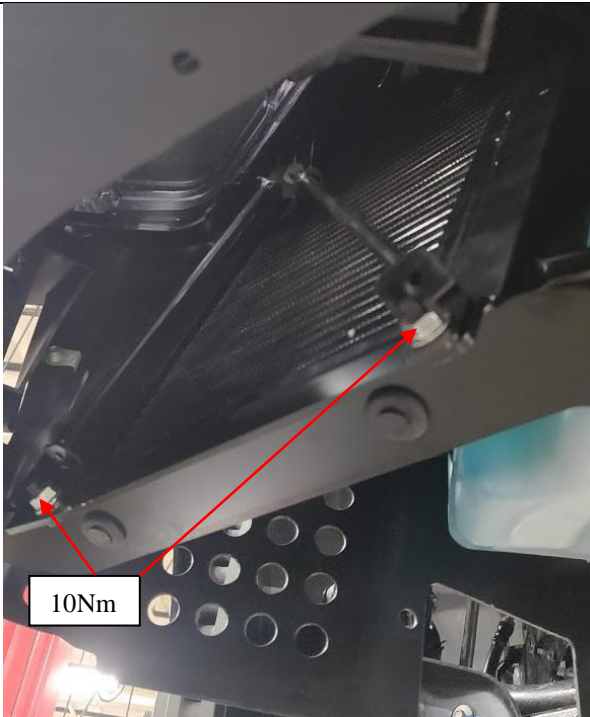

22. Remove Factory Upper Radiator Hose (shown in red) and cut on the straight section of pipe in 2 places, use the radiator T for fitment test prior to cutting (1320-18K323-AA)

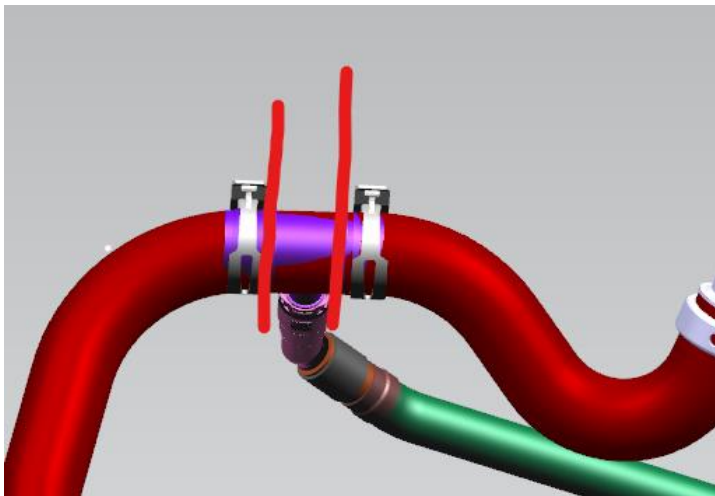

23. Use qty 2 power grip clamp (32954) on the hose you just cut and install the radiator T (1320-18K323-AA) onto the hose. Orient in vehicle to match up to previously installed AUX hose (1320-18N325-AA) and then heat power grip clamps to a tight seal. Connect quick connect

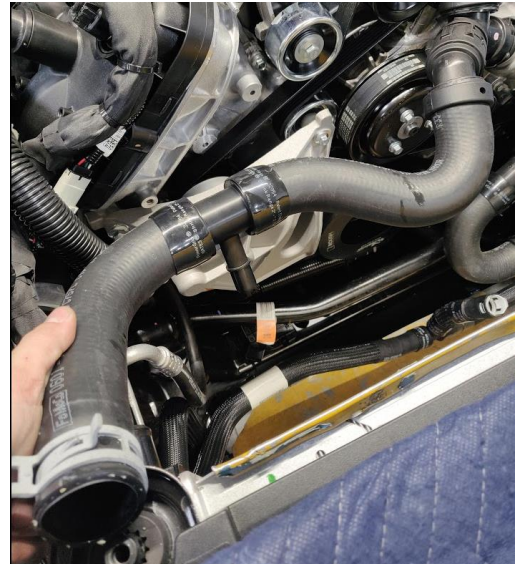

24. Locate lower radiator hose going from Thermostat outlet to lower of radiator, on the straight section make 2 cuts to install the second radiator T (1320-18K323-AA)



25. Slide qty 1 power grip clamp (32954) on each side of the hose you just cut and install the radiator T (1320-18K323-AA) onto the hose. Orient in vehicle to match up to previously installed AUX hose (1320-18K497-AA) and then heat power grip clamps to a tight seal. Connect quick connect.

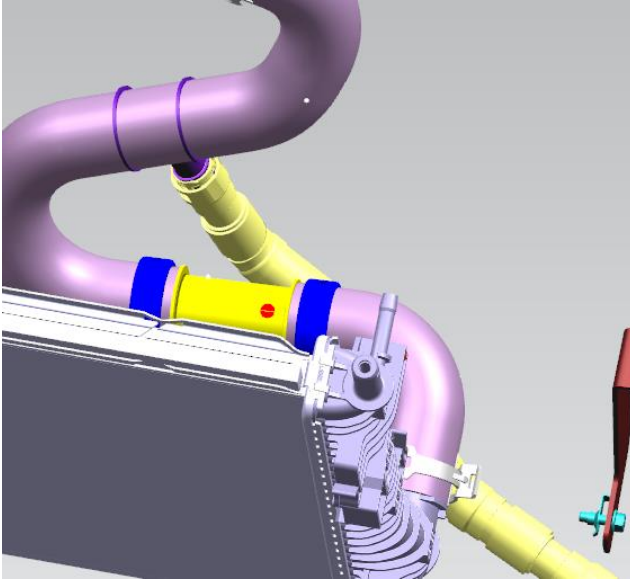

27. Using template available on Roushperformance.com, mark the appropriate cut points for the side vents.



26. Install hoses onto intercooler pump using constant tension clamp from previous install. Lower Hose PN: 1320-18K498-AA

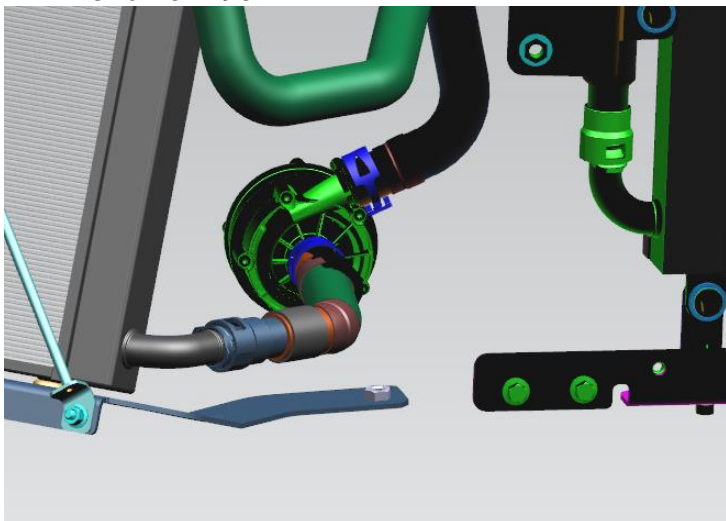

28. Install qty 7 (25112) on each fender extractor (1320-16C804-AA & 1320-16C803-AA)



29. Apply Rust Inhibitor on bare sheetmetal



30. Install RH/LH Heat extractor onto vehicle
RH: 1320-16C804-AA
LH: 1320-16C803-AA



32. Reinstall Fascia components removed in beginning of installation.

Undertray bolts: 2 Nm
Fender Bolts: 5Nm
Bumper Top Bolts: 2Nm

33. Flash Vehicle with latest Calibration if not up to date.

31. Install Closeout panel from inside of fender liner, if fender liner wasn't removed to drill the vent holes, it will need to be removed during this step. Use qty 6 hex nuts (37332) Per side to install, torque to 3Nm



FENDER LINER DRILL TEMPLATE

CUT OUT AND TAPE ON FENDER LINER

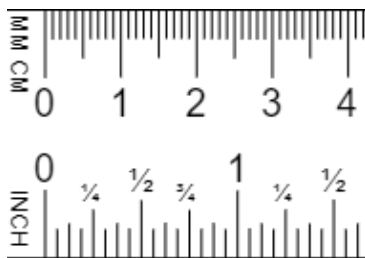
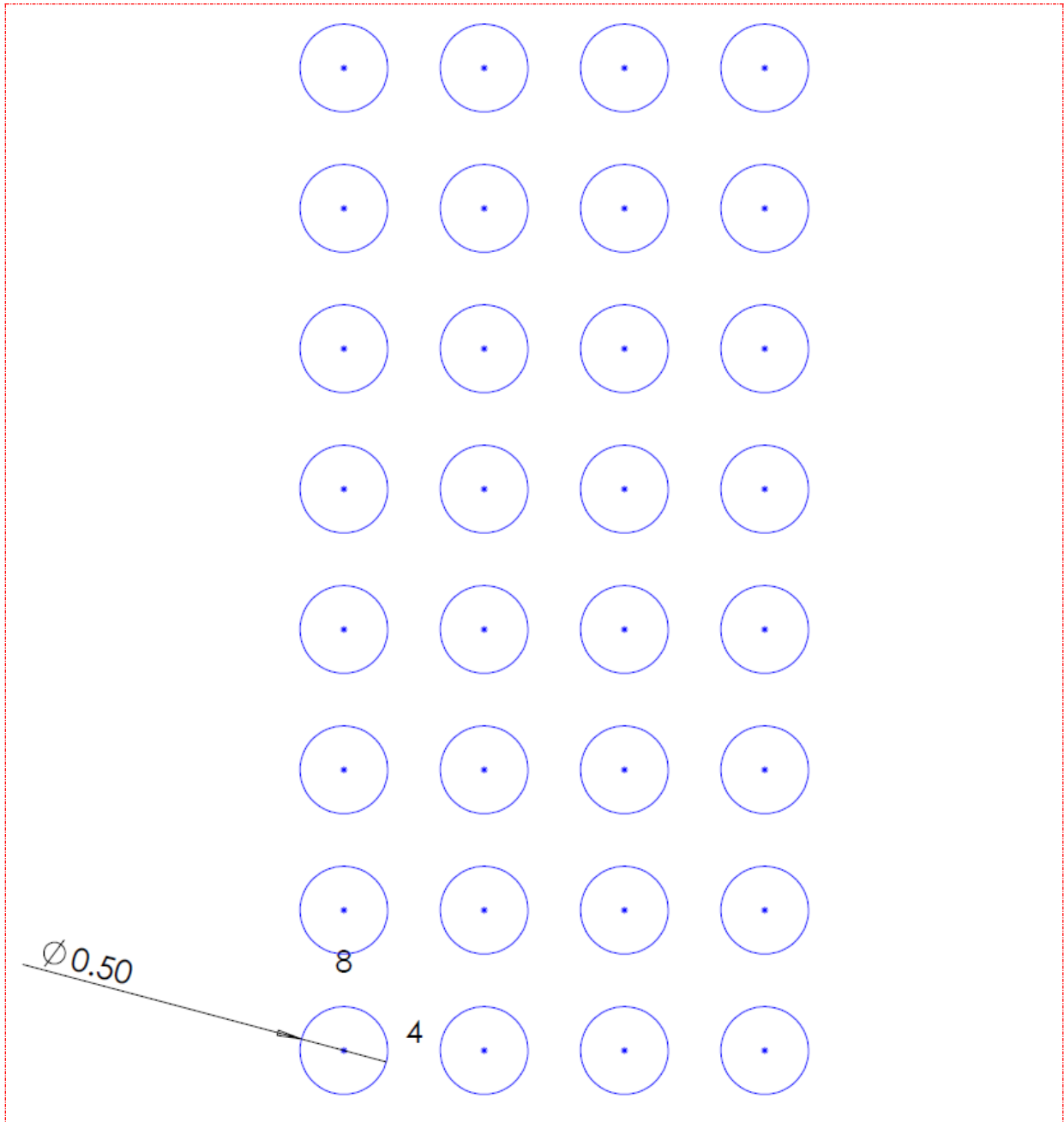



ROUSH
P E R F O R M A N C E

