

ROUSH Active Exhaust

Installation Instructions

P/N: 422293 (R1322-5321OE-AA)

Fastback GT V8 - Convertible GT V8



ROUSHPERFORMANCE.COM | 800.59.ROUSH

ROUSH Active Exhaust Installation Instructions

P/N: 422293 (R1322-5231OE-AA)
Fastback GT V8 – Convertible GT V8



Application: 2018-2023 S550 Ford Mustang

Important Note:

Before installing the ROUSH Performance Product, please read through the installation procedure and verify that all items are present. If you are missing hardware or have any questions, please contact ROUSH Performance at 1-800-59-ROUSH, 9:00 AM to 5:00 PM EST.

Contents

Packing List for 2018+ Mustang GT Active Quad-Tip Exhaust Kit (Coupe and Convertible)	3
Equipment and Supplies Required	4
Safety Precautions.....	5
Work Safely!.....	5
Rear Sub Frame Removal.....	6
Removing Stock Exhaust	6
Quad Tip GT V8 Exhaust Installation.....	8
Active Exhaust Installation.....	11
Drill Templates.....	14

PACKING LIST FOR 2018+ MUSTANG GT ACTIVE QUAD-TIP EXHAUST KIT (COUPE AND CONVERTIBLE)

Description	Part Number	Quantity
2018+ Mustang GT ACTIVE OE Active Compatible System	R1322-5231OE	
Muffler V8 Active LH VERT	1315-5232AVCV	1
Muffler V8 Active RH VERT	1315-5230AVCV	1
Tips, Dual Wall Round, Drivers Side	1318-AVTIPLH	2
Tips, Dual Wall Round, Passenger Side	1318-AVTIPRH	2
Washer - 8MM X 20 Mm OD	11101304	2
QUAD TIP MUSTANG EXHAUST HARDWARE KIT	1318-QUADEXHHWK	1
Clamp - 2.5" Torca Accuseal - Tip To Muffler (304ss)	10-0338	4
Exhaust Hanger - Lh	1315-5A261	1
Exhaust Hanger - Rh	1315-5G298	1
Heat Shield Clamps -- 2.5in	16700070	4
Torca Duraseal 2.50" 409 Ss	94-0053	2
Gasket, Exhaust Flange 2013 Focus	CV6Z-9450-C	2
M8-1.25 Din 6923 Steel Class 8 Zinc Flange Nut	NM8X125HF-S437	4
Box 7x4x8.5 Die Cut 32b - Kraft (No Logo)	18-033-DC070408	1
VALVE ASSEMBLY - ACTIVE EXHAUST PIPE WITH VALVE LH	PT00046047	1
VALVE ASSEMBLY - ACTIVE EXHAUST PIPE WITH VALVE RH	PT00046046	1
EXHAUST HEAT SHIELD KIT	1315-5231EXHK	1
Exhaust Heat Shield	1315-5231SHLD	2
M8-1.25 Din 6923 Steel Class 8 Zinc Flange Nut	NM8X125HF-S437	4
M10x30/M8x16 - Exhaust Heat Shield Stud	W717354-S442	4
EXHAUST HARDWARE KIT	1315-5231HWK	1
Rivet Nut M8 X 1.25 - Zinc Plated	95105A191	4
Exhaust Hanger - Rubber Isolator	BR3Z-5A262-B	2
Bolt - M8 X 1.25 X 29 Hex Flange Dogpoint Fully Threaded 8.8	W500224-S437	4
EXHAUST RIV NUT INSTALLATION HARDWARE KIT	R1315-5231HWK	1
Bolt M8x1.25x29	W500224-S437	1
Installation Nut M10x1.5	90592A024	1
CUSTOMER CARE KIT	RETAILDOC-AB	1
RPP Product Im/Prop 65 & Survey Card	1315-P1INST-AC	1
Sticker, ROUSH White 7" X 1.25"	ROUSH-STKR-7x1.25	1

Equipment and Supplies Required

- Small Pick
- Tape Measure
- Scissors
- Masking Tape
- Center Punch
- Marker
- Drill
- 1/8", 1/4" and 17/32" Drill Bits
- Philips Head Screwdriver
- Wire Cutters
- Exhaust Pipe Cutting Tool
- 3/8" Drive Ratchet
- 3/8" Extension
- 7 mm Deep Socket
- 8 mm Socket
- 10 mm Socket
- 3/8" 13 mm Socket
- 3/8" 15 mm Socket
- 17 mm Socket
- 3/8" Torque Wrench
- Flat Head Screwdriver
- Razor Blade
- Deburr Tool
- Corrosion Inhibitor (Motorcraft PMP-19500-6000
Clear Topcoat recommended)

If you are missing any items, please call us toll free at 1-800-59-ROUSH.

LIMIT OF LIABILITY STATEMENT

The information contained in this publication was accurate and in effect at the time the publication was approved for printing and is subject to change without notice or liability. ROUSH Performance Products (RPP) reserves the right to revise the information presented herein or to discontinue the production of parts described at any time.

SAFETY PRECAUTIONS



CAREFULLY READ THE IMPORTANT SAFETY PRECAUTIONS and WARNINGS BEFORE PROCEEDING WITH THE INSTALLATION!

Appropriate disassembly, assembly methods and procedures are essential to ensure the personal safety of the individual performing the kit installation. Improper installation due to the failure to correctly follow these instructions could cause personal injury or death. Read each step of the installation manual carefully before starting the installation.

- Always wear safety glasses for eye protection.
- Place ignition switch in the OFF position.
- Always apply the parking brake when working on a vehicle.
- Block the front and rear tire surface to prevent unexpected vehicle movement.
- If working with a lift, always consult vehicle manual for correct lifting specifications.
- Operate the engine only in well-ventilated areas to avoid exposure to carbon monoxide.
- Do not smoke or use flammable items near or around the fuel system.
- Use chemicals and cleaners in well-ventilated areas.
- Batteries produce explosive gases, which can cause personal injury. Therefore, do not allow flames, sparks or flammable substances to come near the battery.
- Keeps hands and any other objects away from the radiator fan blades.
- Keep yourself and your clothing away from moving parts when the engine is running.
- Do not wear loose clothing or jewelry that can get caught in rotating parts or scratch surface finishes.
- Allow the engine, cooling system, brakes and exhaust to cool before working on a vehicle.

WORK SAFELY!

Perform this installation on a good clean level surface for maximum safety and with the engine turned off.

NOTE: For convertible installation ONLY, follow the section below titled "Rear Sub Frame Removal"

REAR SUB FRAME REMOVAL

1. Convertible Mustangs have a rear sub frame connector that needs to be removed in order to install the ROUSH exhaust system. In order to do so, remove sixteen (16) 15 mm bolts and lower the sub frame connector to the ground with the help of an assistant. After removal, follow the remaining steps in the installation guide before finally following the reverse of this step to re-install the sub frame connector. Torque to 46 lb-ft (63 Nm).

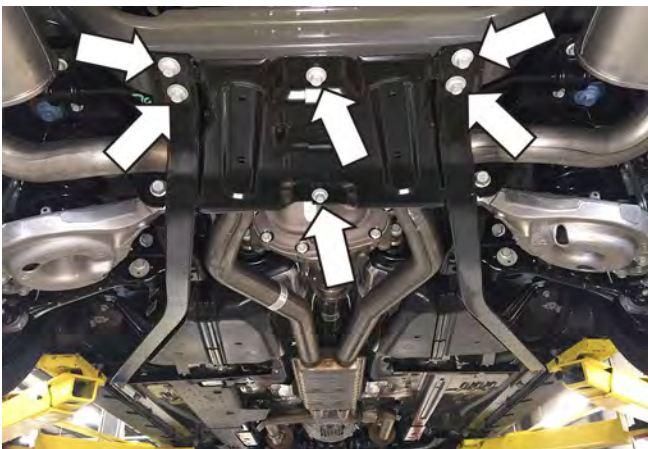

REMOVING STOCK EXHAUST

1. Support the muffler prior to altering the exhaust as to not damage the actuator or harness when lowering muffler assembly.



2. Disconnect wire harness from electronic actuators, Remove electronic actuator, flange nuts, spring, and backing plate from mufflers to be removed. Set aside to be used later for install on Roush active valve assemblies.

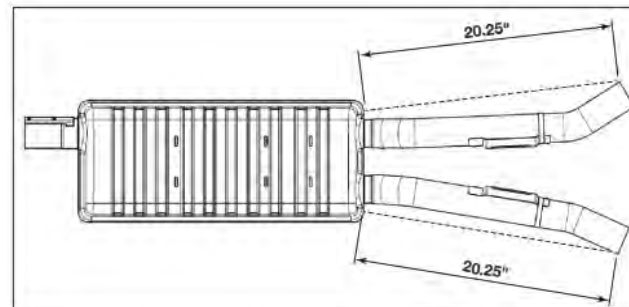

Exhaust Cut Point



3. Remove the two (2) 13 mm bolts that retain the exhaust hangers on the IRS sub frame. Push up on heat shields.

4. Using a suitable exhaust pipe cutting tool, cut completely through the stock exhaust in the two (2) locations shown below. Unhook each exhaust hanger from the sub frame and remove each muffler assembly by sliding the inlets down and forward to extract the rear exhaust hangers from their mounts.

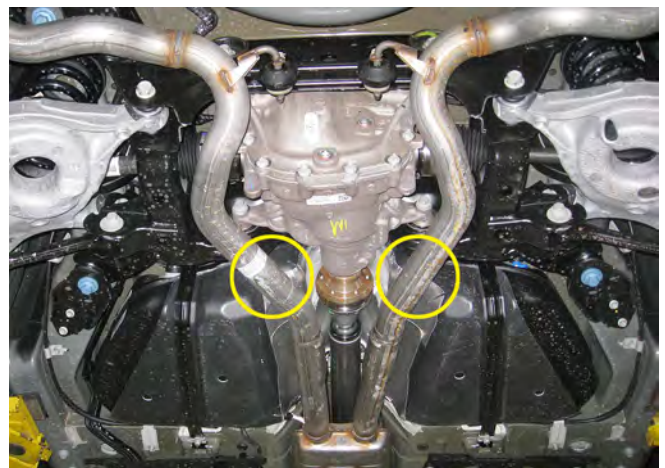

QUAD TIP GT V8 EXHAUST INSTALLATION

1. With the rear wheels off of the ground remove and replace the rear sway bar bushing bolts one at a time with the new studs (P/N: W717354) that are found in the heat shield kit (P/N: 1315-5231EXHK). Install the heat shields (P/N: 1315-5231SHLD) with the nuts (P/N: NM8X125HF) that are included in the heat shield kit.



2. Locate the template onto the rear chassis sub frame as shown in the pictures below and mark the drill holes with a center punch. Use the same template to mark the holes on both the RH and LH sides of the vehicle.

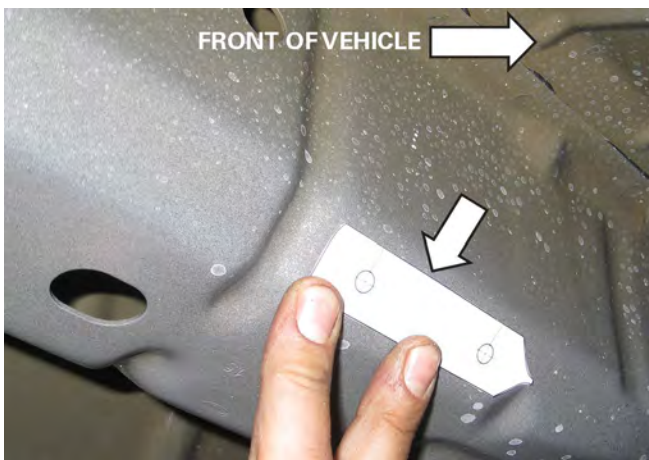

3. Drill all four (4) pilot holes that were marked in the previous step with a 1/8" drill bit followed by a 17/32" drill bit.



4. Deburr the drilled holes and apply automotive clear coat. Install four (4) rivet nuts (P/N: 95105A191) using the supplied bolt and nut from the rivet nut installation kit (P/N: R1315-5231HWK). Insert the nut onto the bolt and thread the bolt into the rivet nut. Hold the nut with a 17 mm wrench and tighten the bolt nut with a 10 mm socket until the rivet nut is fully seated.

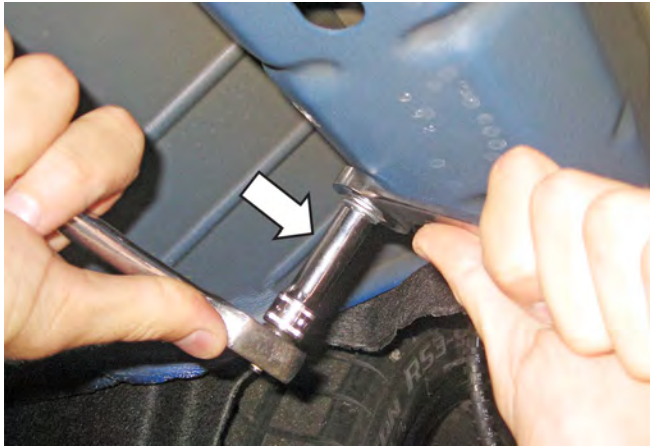

- Remove both LH and RH exhaust hangers from vehicle with a 13 mm socket. Prepare to cut both hangers with cut off tool of choice (example: cut off wheel).

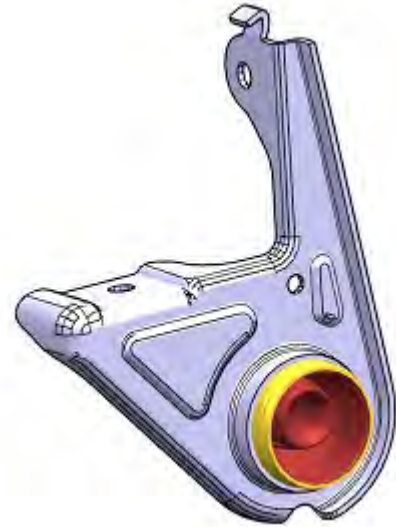

- Make cuts on both RH and LH exhaust hangers as pictured.

- Install the two (2) supplied exhaust hangers (P/N: 1315-5A261 and 1315-5G298) and four (4) bolts (P/N: W500224) as shown below. Torque to 18 lb-ft (25 Nm).

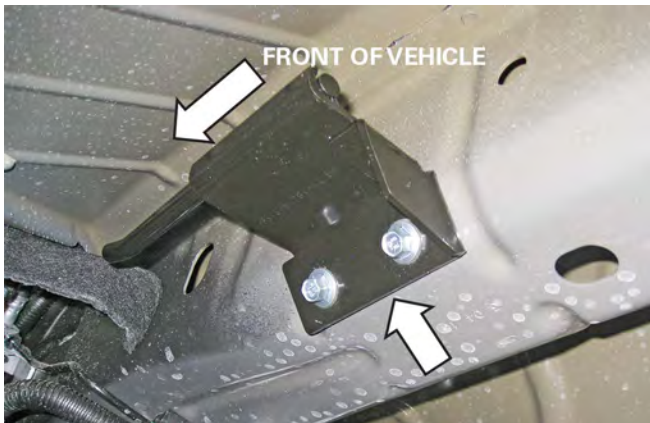

8. Locate (2) washers – 3/8" X .406" ID X 0.812" OD (11101304). Place them in between the modified bracket and the frame of the vehicle. Reinstall the modified exhaust hangers with the takeoff flange bolts. Torque to 25 Nm. (18lb.ft).



10. Slide the rubber exhaust isolators (P/N: BR3Z-5A262) onto the rear muffler hangers. Install the block off gaskets (P/N: CV6Z-9450) followed by the block off plates and finally the outlet couplers onto both of the flanged outlets on the muffler assemblies (P/N: 1315-5232AVCV and 1315-5230AVCV). Secure the outlet couplers with the four (4) nuts (P/N: NM8X125HF) and torque to 18 lb-ft (25 Nm). Slide on the heat shield clamps (P/N: 1600070). Slide the exhaust pipe clamps (P/N: 94-0053) onto each outlet of the forward section of the factory exhaust.



9. Remove the two (2) IRS sub frame mounted exhaust hangers from the stock exhaust system and slide them onto each side of the ROUSH exhaust.

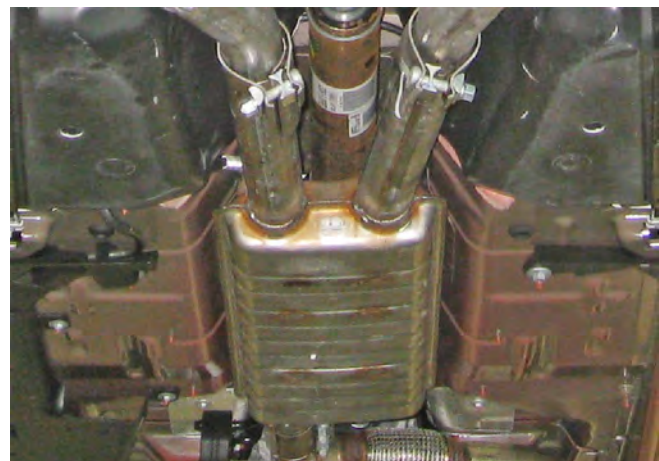

11. Install each side of the ROUSH exhaust system by inserting the rear exhaust hangers first and then sliding each side forward to fully seat the inlets with the forward section of the stock exhaust. Be sure to connect the rubber isolators to the hangers that were installed in step 7 and also reinstall the two (2) IRS sub frame exhaust hangers with the two (2) 13 mm bolts that were removed in step 2 and torque to 18 lb-ft (25 Nm). Tighten the heat shield clamps. Torque the exhaust pipe clamps to 35 lb-ft (47 Nm).



ACTIVE EXHAUST VALVES INSTALLATION

1. Begin the installation by first opening the hood and disconnecting the battery (refer to your owner's manual for guidance).
2. Locate the active exhaust valve assemblies (P/N's: PT00046046 and PT00046047), two (2) gaskets (CV6Z-9450-C), and four (4) flange nuts (NM8X125HF-S437). Install PT00046047 on the left hand muffler. Install PT00046046 on the right hand muffler. Install the active exhaust connector and torque the nuts to 25Nm.
3. Slide each exhaust tip (P/N: 1318-AVTIPLH [left hand] and 1318-AVTIPRH [right hand]) onto the muffler outlets with the exhaust tip clamps (P/N: 10-0338). Align the tips to the rear valance. Torque the exhaust tip clamps to 35 lb-ft (47 Nm).

NOTE: If your vehicle is a convertible be sure to re-install the rear sub frame by reversing step 1 titled "Rear Sub Frame Removal".





4. Reconnect the battery, start the vehicle and test your new ROUSH active exhaust.

Congratulations, the installation is complete!

DRILL TEMPLATES

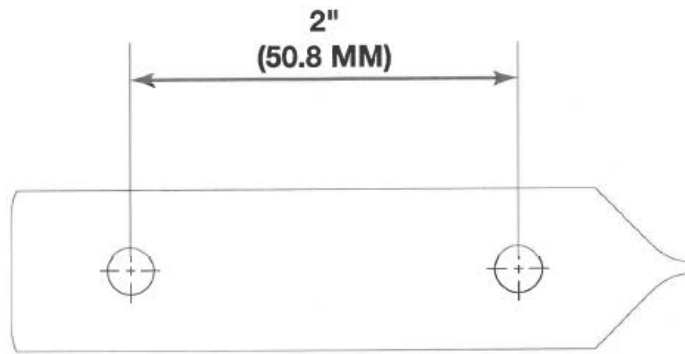

Note: Print this page at 100% scale and verify that the drill template has printed properly by measuring it after it is printed.