



## INSTALLATION GUIDE: AWE EXHAUST SUITE FOR THE FORD MUSTANG S650 GT QUAD TIP

For up-to-date fitment information, please visit the product page on [AWE-Tuning.com](https://www.AWE-Tuning.com).

### THIS GUIDE IS INTENDED FOR THE FOLLOWING PART NUMBERS:

- 3020-42650 AWE Track Edition Exhaust for S650 Mustang GT Fastback - Quad Chrome Silver Tips
- 3020-43650 AWE Track Edition Exhaust for S650 Mustang GT Fastback - Quad Diamond Black Tips
- 3025-42650 AWE SwitchPath™ Exhaust for S650 Mustang GT Fastback - Quad Chrome Silver Tips
- 3025-43650 AWE SwitchPath™ Exhaust for S650 Mustang GT Fastback - Quad Diamond Black Tips

Welcome to the AWE family, and congratulations on your purchase of the AWE Exhaust for the Mustang GT Quad Tip

Exquisite build quality and craftsmanship, coupled with industry leading performance, distinguish this exhaust system from all others.

\*For up to the minute fitment information, be sure to visit the AWE website. As always, AWE Performance Specialists are standing by for any questions, [right here](#).

# PARTS LIST (GT QUAD TIP SWITCHPATH)



Inspect **ALL** parts prior to disassembly of vehicle; If damaged or **MISSING**, please contact the place of purchase immediately.

Symbol	Part Number	Description	QTY
	F65	Mustang GT H-pipe OEM adapter	2
	F66	Mustang GT H-pipe	1
	XG	Mustang GT DS Cat Back Axle Tube	1
	XJ	Mustang GT PS Cat Back Axle Tube	1
	F73	S650 Mustang GT Quad Tip Switchpath DS Rear	1
	F74	S650 Mustang GT Quad Tip Switchpath PS Rear	1
<b>A</b> >>	180300	AWE 3.0" Band Clamp	6
<b>B</b> >>	3910-41010	**Only takes 1 of these kits per set of 2 or 4 tips** Hardware Kit for Integrated Clamp Style Exhaust Tips - Quad	1
<b>C</b> >>	7130K59	7.5 INCH ZIP TIE (MEDIUM)	6
<b>D</b> >>	180012	4.00" x 3.00" exhaust tip Chrome Plated	4
	180013	4.00" x 3.00" exhaust tip Black Plated	4

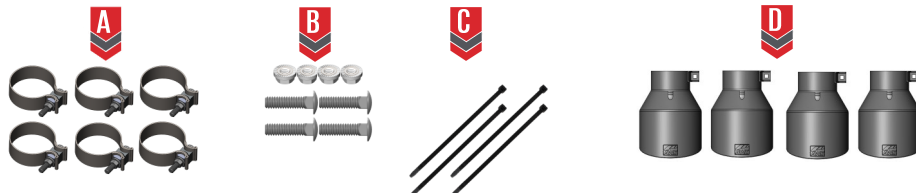
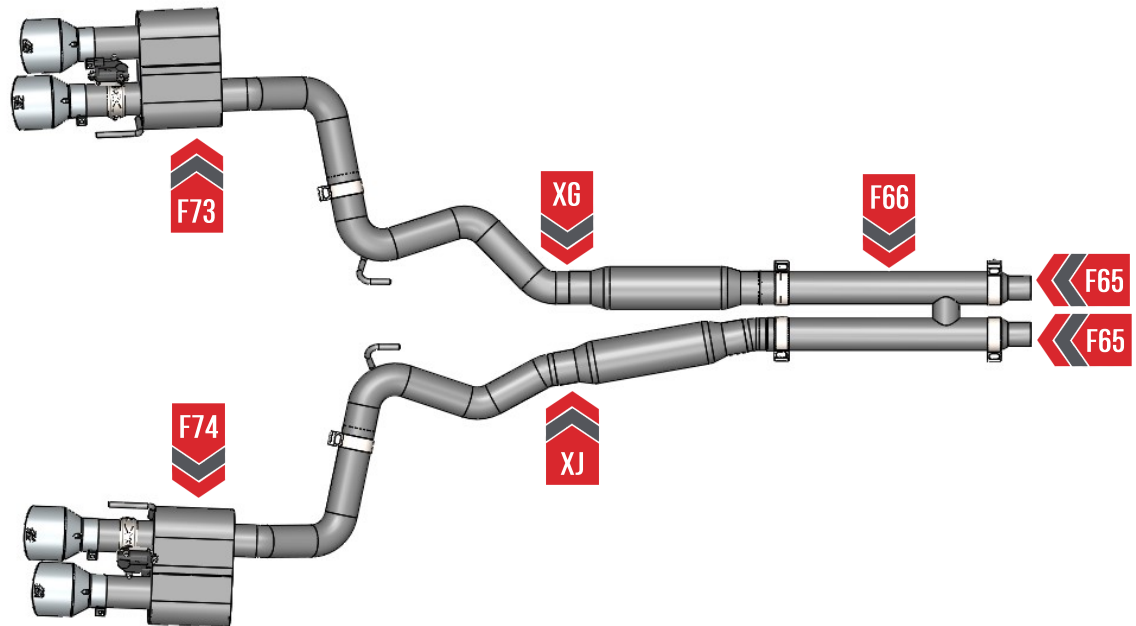

# PARTS LIST (GT QUAD TIP TRACK)



Inspect **ALL** parts prior to disassembly of vehicle; If damaged or **MISSING**, please contact the place of purchase immediately.

Symbol	Part Number	Description	QTY
	F65	Mustang GT H-pipe OEM adapter	2
	F66	Mustang GT H-pipe	1
	XG	Mustang GT DS Cat Back Axle Tube	1
	XJ	Mustang GT PS Cat Back Axle Tube	1
	F71	S650 Mustang GT Quad Tip DS Track Rear	1
	F72	S650 Mustang GT Quad Tip PS Track Rear	1
<b>A</b> >>	180300	AWE 3.0" Band Clamp	6
<b>B</b> >>	3910-41010	**Only takes 1 of these kits per set of 2 or 4 tips** Hardware Kit for Integrated Clamp Style Exhaust Tips - Quad	1
<b>C</b> >>	150016	SBS valve motor simulator	2
<b>D</b> >>	98380A457	416 Stainless Steel Dowel Pins, 7/64" Diameter, 1" Long	2
<b>E</b> >>	91287A136	M6X1X16SS HEX HEAD BOLTS	6
<b>F</b> >>	7130K59	7.5 INCH ZIP TIE (MEDIUM)	6
	180012	4.00" x 3.00" exhaust tip Chrome Plated	4
<b>G</b> >>	180013	4.00" x 3.00" exhaust tip Black Plated	4

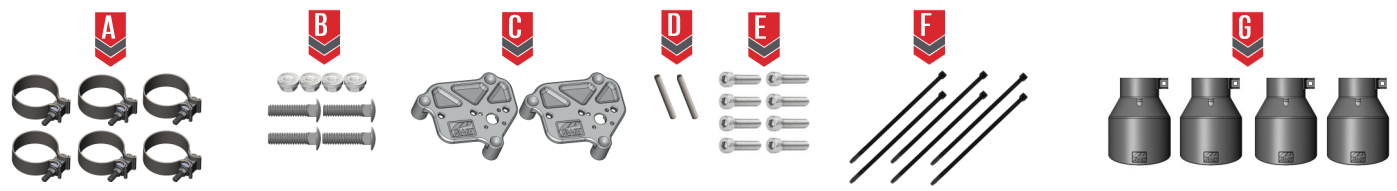
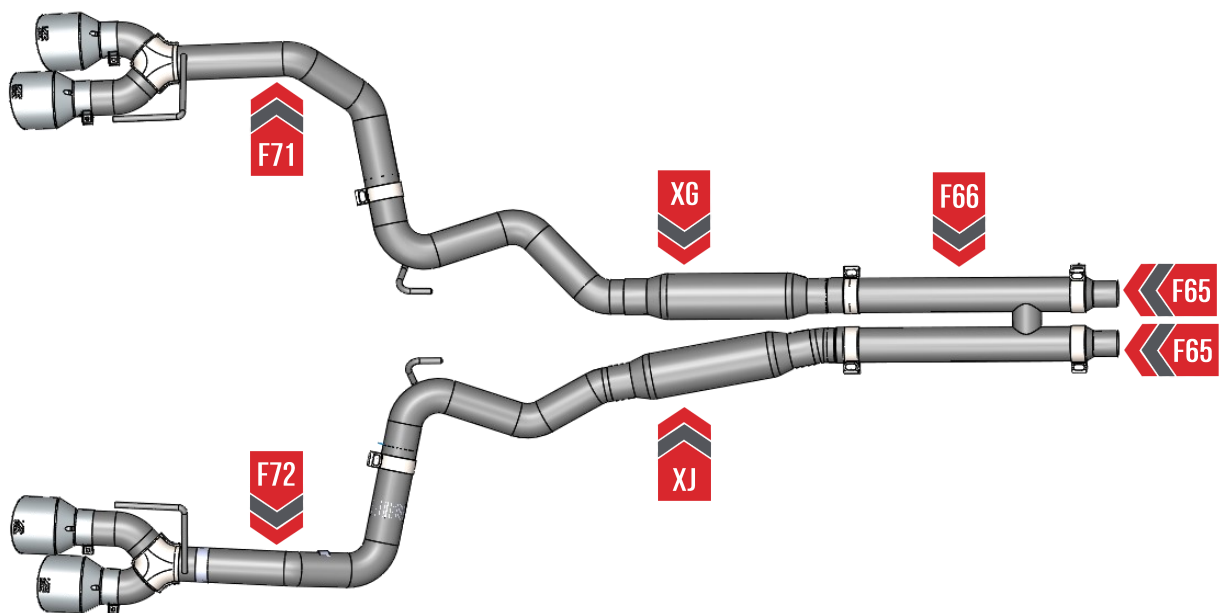



**NOTE:** Always refer to the manufacturer's service manual for precise torque specifications on all OEM fasteners.



**CAUTION:** The exhaust may be **VERY HOT** — allow adequate time for the system to cool down before disassembly. Severe burns and injury will occur if skin comes into contact with a hot exhaust system.

## STEP 1



**Soak all bolts and rubber hangers in penetrating oil before starting any work.**

1. Remove the factory splashguard shown at **(A)**. The splashguard will be reinstalled later using OE hardware.
2. Unplug the valve motor wiring harnesses located at **(B)**.
3. Loosen the OE clamps, shown at **(C)**.
4. Remove the OE hardware holding the hangers shown at **(D)**.
5. Remove the OE hardware holding the hangers, shown at **(E)**.
6. Remove the OE Exhaust

**Note:** All of the OE hangers will be reused with your AWE exhaust

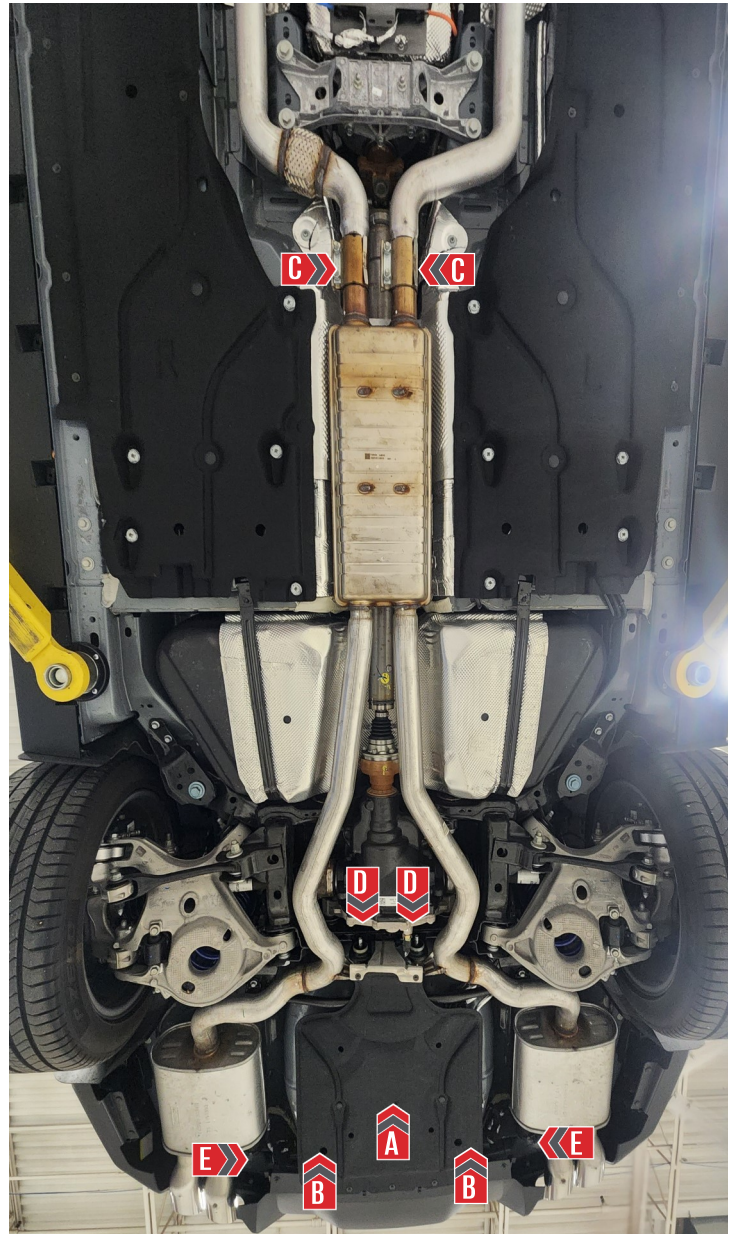

## STEP 2

Gather your AWE H-Pipe (**F66**), and your AWE H-Pipe OEM adapters (**F65**). Slide the 2 OEM adapters into the expanded ends, as shown in **Figure 2**.

Using two of the provided clamps, fully tighten down the clamps on the expanded ends of the tubes.

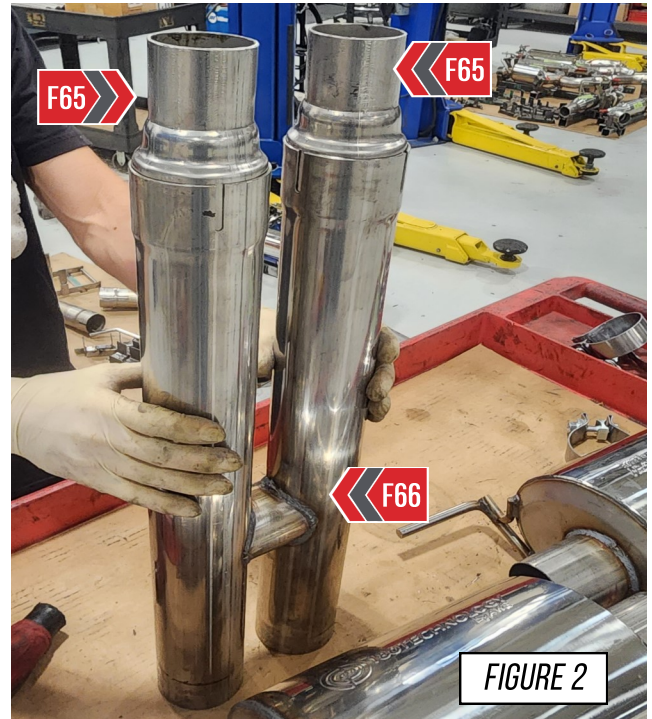

FIGURE 2

## STEP 3

It is crucial to install each section and exhaust band clamps correctly to prevent loose joints, exhaust leaks and rattles.

**Arrow A** shows the expanded pipe and the preinstalled exhaust clamp being brought up to the corresponding pipe.

**Arrow B** shows the overlapping pipe installed correctly over the corresponding pipe.

**Arrow C** shows the exhaust band clamp being brought to the edge of the expanded pipe.



### NOTES:

- **Do not** fully torque any exhaust clamp until the entire exhaust has been installed and adjusted.
- Torque specification is a **minimum** of 60 ft/lbs

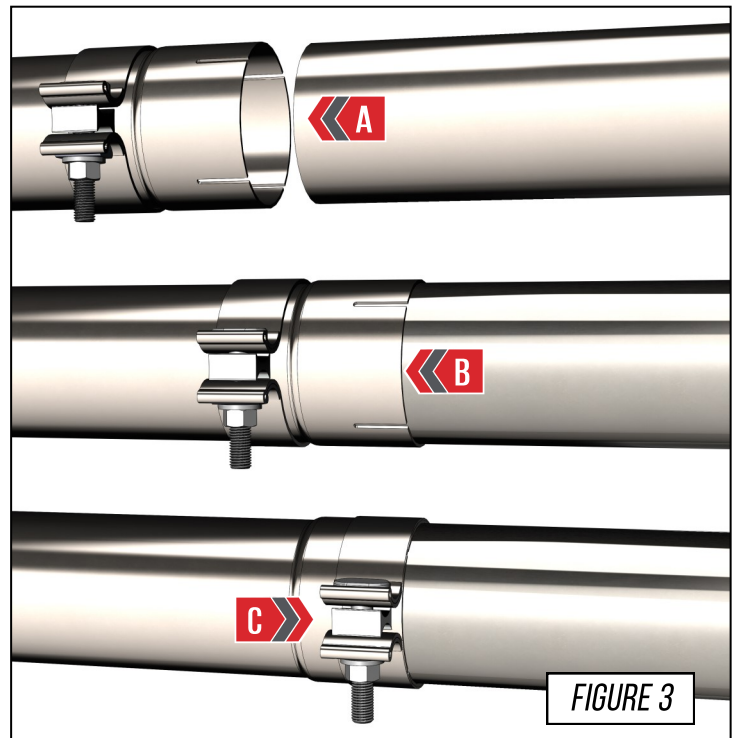
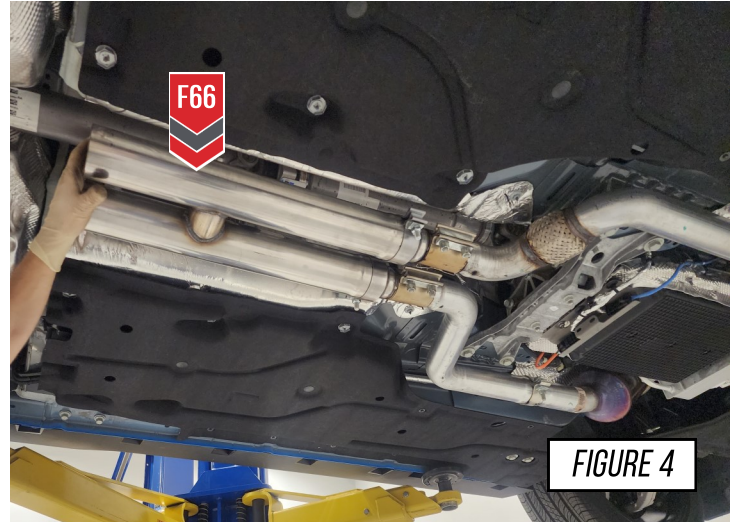

FIGURE 3

## STEP 4

With your H-pipe fully assembled, install your AWE H-pipe using the OE sleeve clamps, as shown in **Figure 4**.

**Note:** It is important to rotate the H-pipe during installation so it is level with the ground, to achieve correct fitment.



## STEP 5

At this point remove the hangers from the OE system as shown in **Figure 5-1**, **Figure 5-2**, and **Figure 5-3**.

While removing the hangers near the tips remove the valve wiring harness shown in **Figure 5-3**. These will be reused later.

**Only reinstall the hangers from Figure 5-1 into the car.**

Slide the hangers from **Figure 5-2**, and **Figure 5-3** onto their respective driver side, and passenger side outlet tubes.

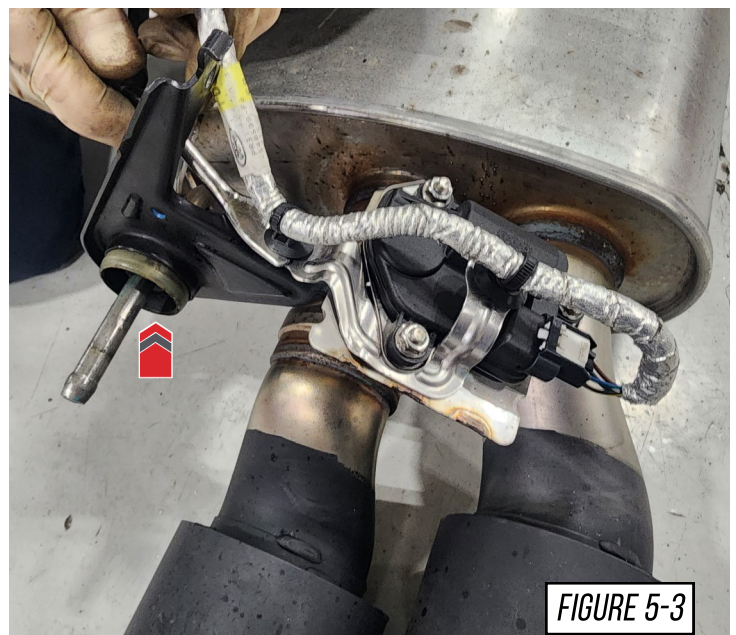
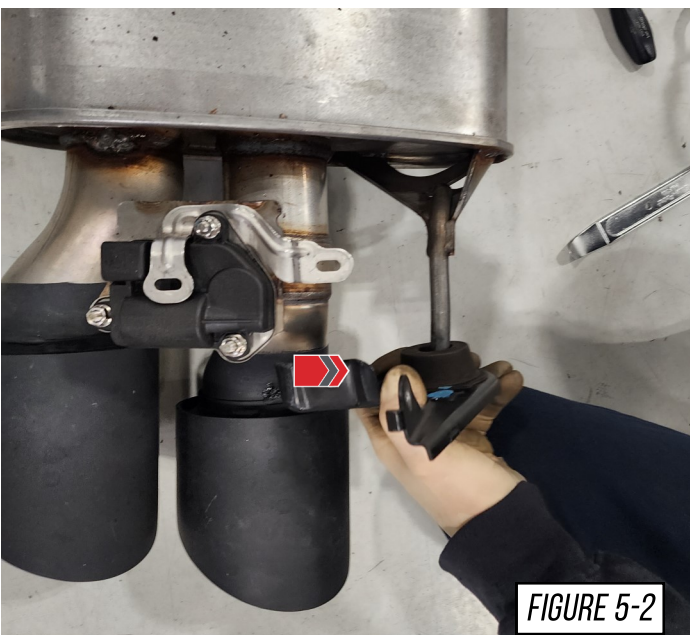
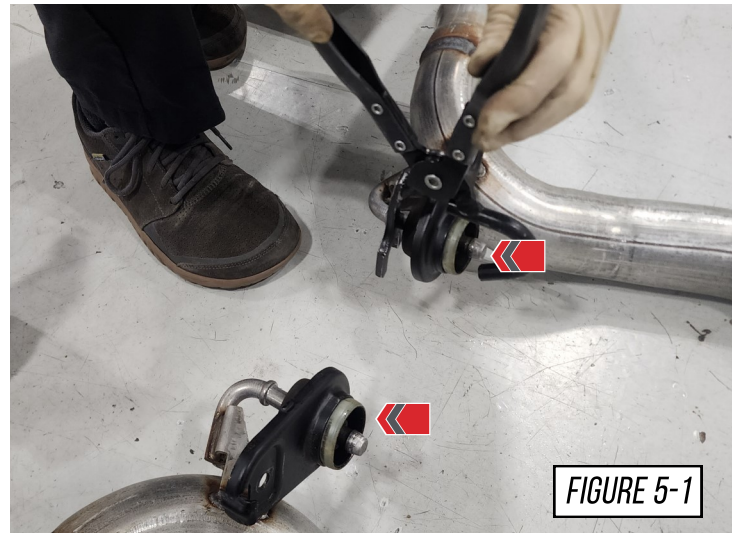

## STEP 6

Gather your AWE Driver side resonator tube (**XG**).

First slide the hanger bar into the OE driver side hanger that was reinstalled in **Step 5**, shown at (**A**), in **Figure 6**.

Then slide a clamp on the expanded slip joint, and bottom out the slip joint on the rear side of your AWE H-pipe (**F66**).

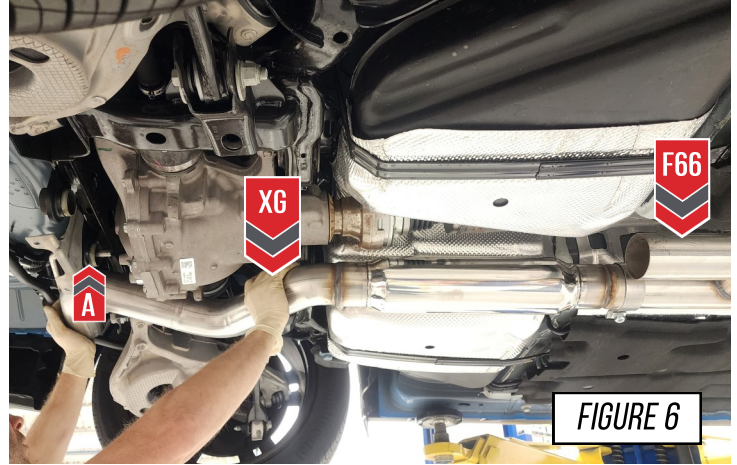

## STEP 7

Gather your AWE Passenger side resonator tube (**XJ**).

First slide the hanger bar into the OE passenger side hanger that was reinstalled in **Step 5**, shown at (**A**), in **Figure 7**.

Then slide a clamp on the expanded slip joint, and bottom out the slip joint on the rear side of your AWE H-pipe (**F66**).

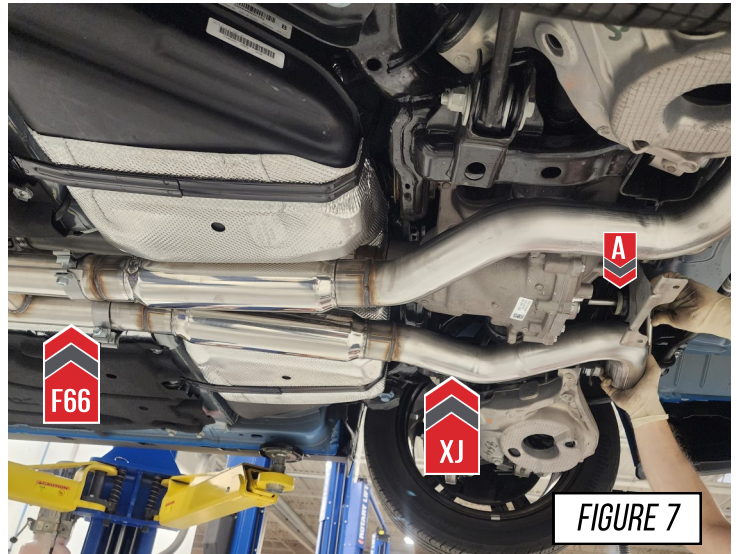



## STEPS 8-11 ARE FOR SWITCHPATH SYSTEMS ONLY



### STEP 8

With the OE rear exhaust hangers installed on to your AWE SwitchPath rear sections (**F73/ F74**) Secure your OE wiring harnesses to the motors (**A**), and hangers (**B**) of their respective sides, as shown in **Figure 8**.

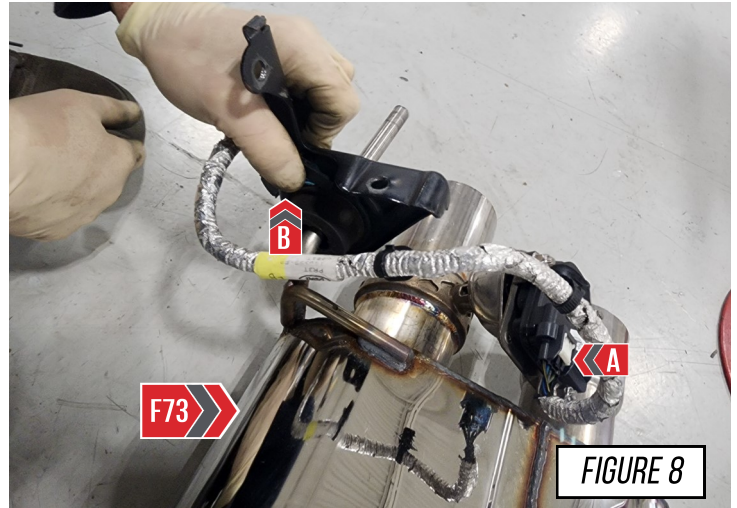

### STEP 9

Gather your AWE driver side SwitchPath section (**F73**), slide a provided clamp over the expanded end, and bottom out the slip fit onto the back of your driver side resonator tube (**XG**), as shown in **Figure 9-1**.

Next rotate the driver side outlet tube up into position, and secure it in place by reinstalling the OE hanger, as shown at (**A**) in **Figure 9-2**.

Snug the clamp down but do not fully tighten it at this time.

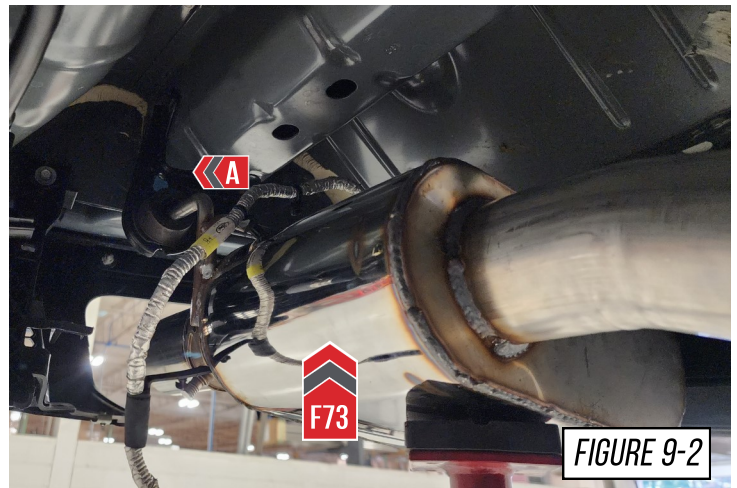
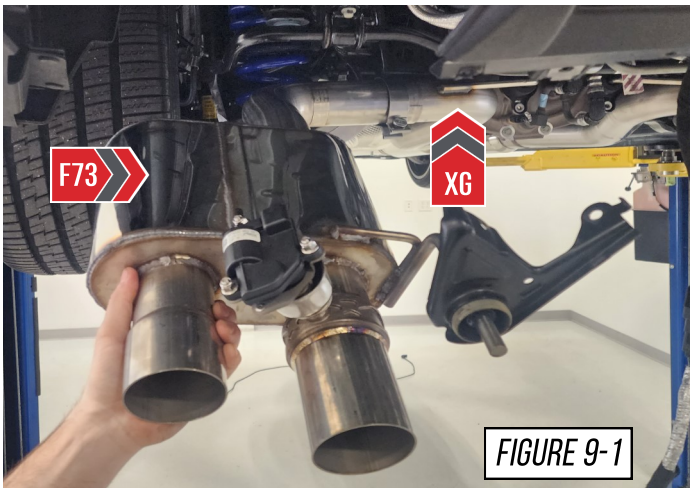



## STEP 10

Gather your AWE passenger side SwitchPath section (**F74**), slide a provided clamp over the expanded end, and bottom out the slip fit onto the back of your driver side resonator tube (**XJ**), as shown in **Figure 10-1**.

Next rotate the driver side outlet tube up into position, and secure it in place by reinstalling the OE hanger, as shown in **Figure 10-2**.

Snug the clamp down but do not fully tighten it at this time.

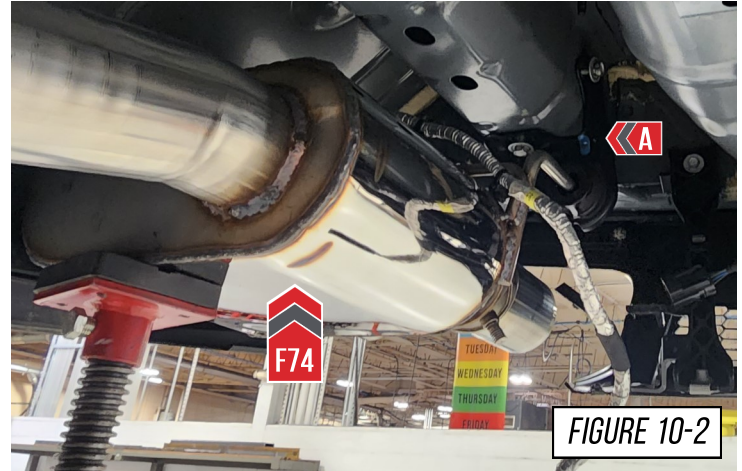
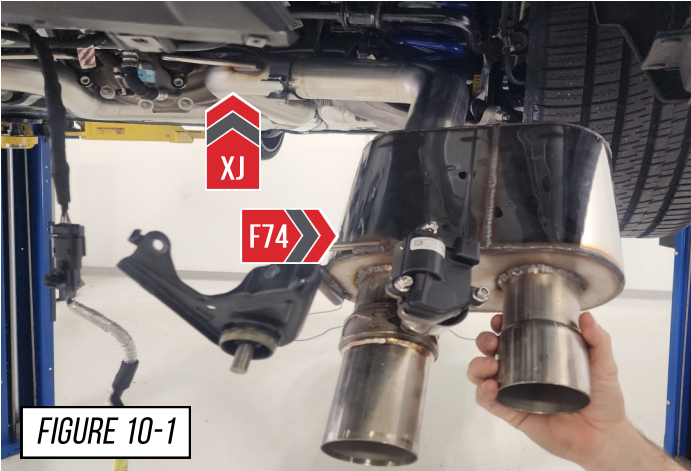

## STEP 11

Next plug the wiring harness back into the vehicle, reattach the clip to the hanger, as shown at **(A)**. Then using a provided zip tie secure the excess harness wires to the underside of the vehicle, as shown at **(B)** in **Figure 11**.

Repeat this for the opposite side of the vehicle.

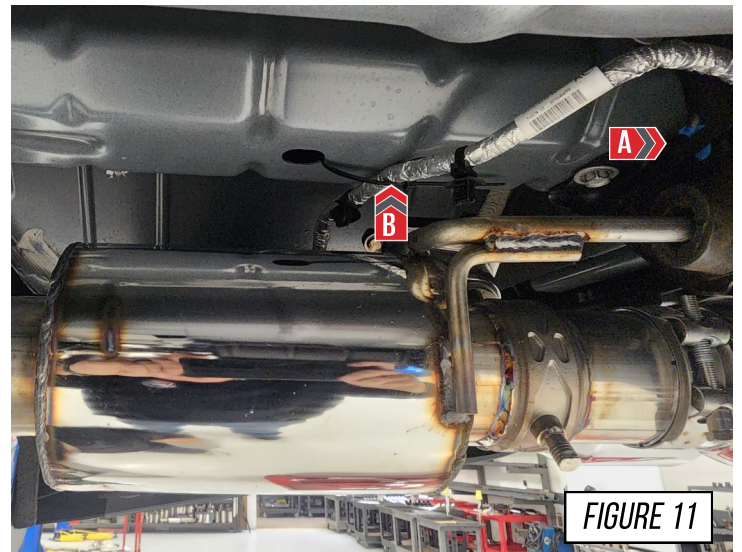



Steps 12– 18 ARE FOR TRACK SYSTEMS ONLY



## STEP 12

Gather your AWE driver side track (F71), slide a provided clamp over the expanded end, and bottom out the slip fit onto the back of your driver side resonator tube (XG), as shown in **Figure 12-1**.

Next rotate the driver side outlet tube up into position, and secure it in place by reinstalling the OE hanger, as shown in **Figure 12-2**.

Snug the clamp down but do not fully tighten it at this time.

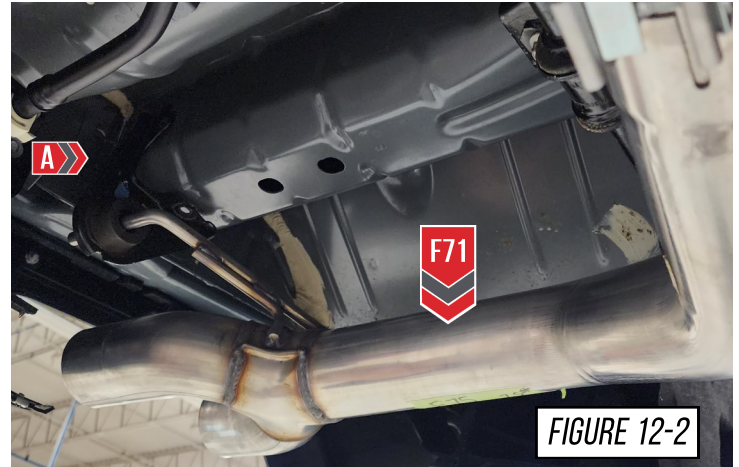
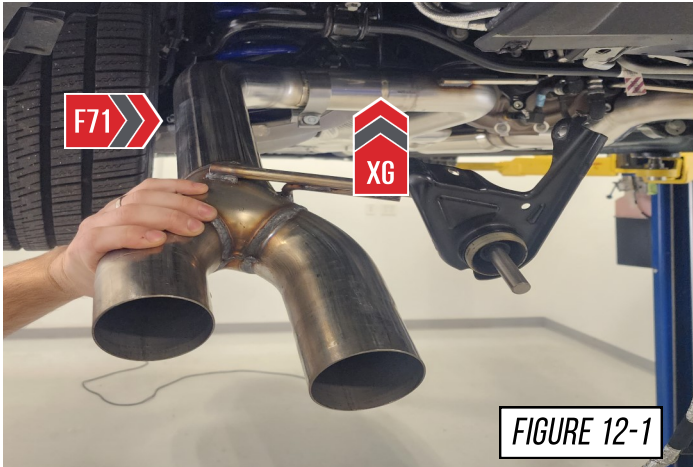

## STEP 13

Gather your AWE driver side track (F72), slide a provided clamp over the expanded end, and bottom out the slip fit onto the back of your driver side resonator tube (XJ), as shown in **Figure 13-1**.

Next rotate the driver side outlet tube up into position, and secure it in place by reinstalling the OE hanger, as shown in **Figure 13-2**.

Snug the clamp down but do not fully tighten it at this time.

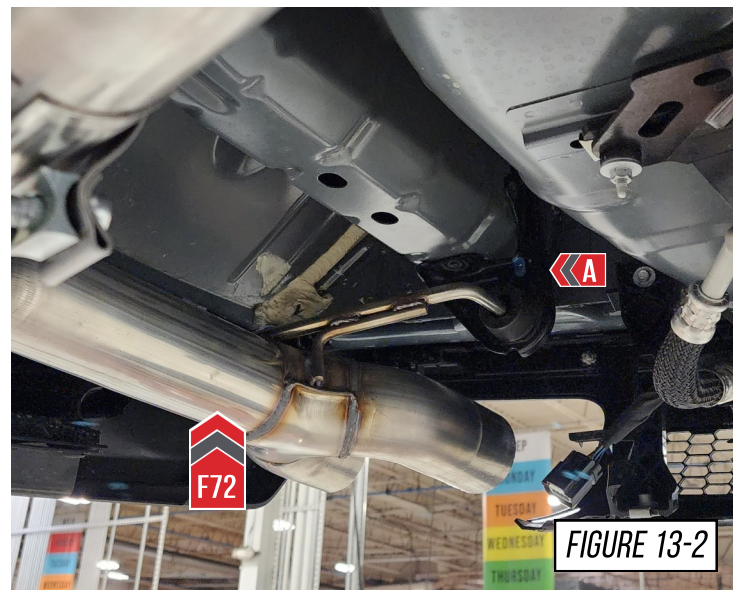
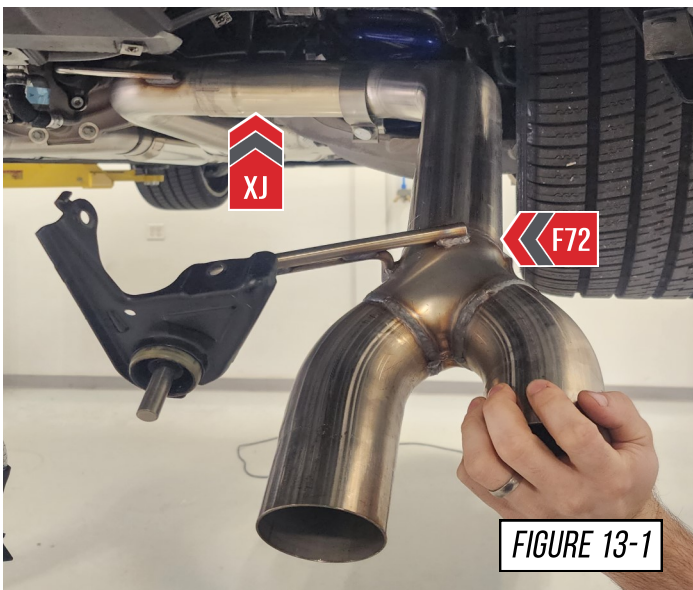

## STEP 14

Remove the OE valve motors from the OE driver side muffler, as shown in **Figure 14-1**, and from the OE passenger side muffler as shown in **Figure 14-2**.



FIGURE 14-1



FIGURE 14-2

## STEP 15

Gather your AWE valve simulator brackets, dowel pins, hardware, and OE motors, as shown in **Figure 15-1**.

Next align the dowel pin, and slot in the OE motor in the simulator bracket, as shown in **Figure 15-2**.

Use the provided hardware to secure the OE motor to the simulator bracket as shown in **Figure 15-3**.

Repeat these steps for the second motor.



FIGURE 15-1



FIGURE 15-2

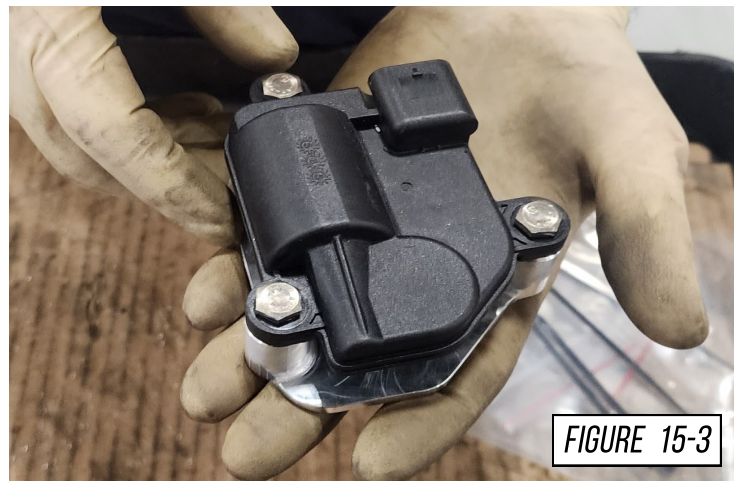
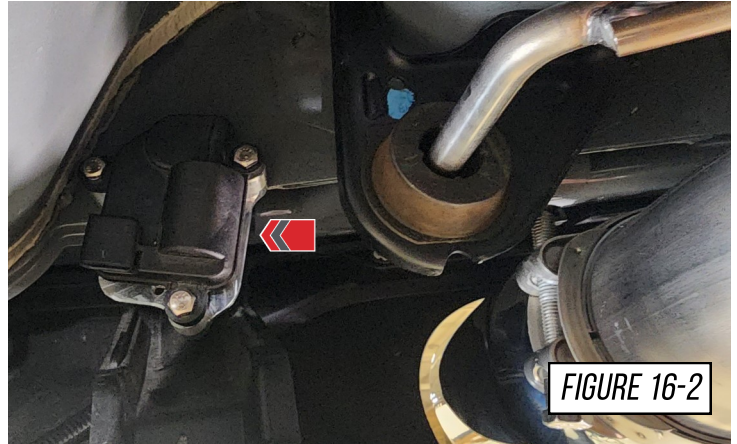
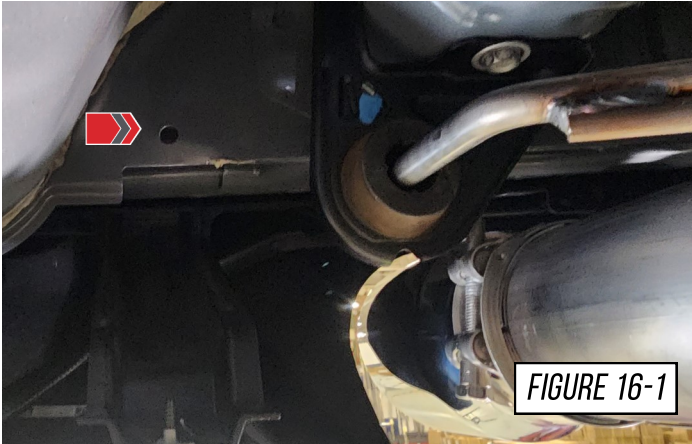

FIGURE 15-3

## STEP 16

Feed a provided bolt through the hole in the body of the frame near the driver side tip outlet, as shown in **Figure 16-1**.

Next thread the bolt into the top hole of the valve simulator with the plug pointing down, as shown at in **Figure 16-2**.



## STEP 17

Feed a provided bolt through the hole in the body of the frame near the passenger side tip outlet, as shown in **Figure 17-1**.

Next thread the bolt into the top hole of the valve simulator with the plug pointing down, as shown at in **Figure 17-2**.

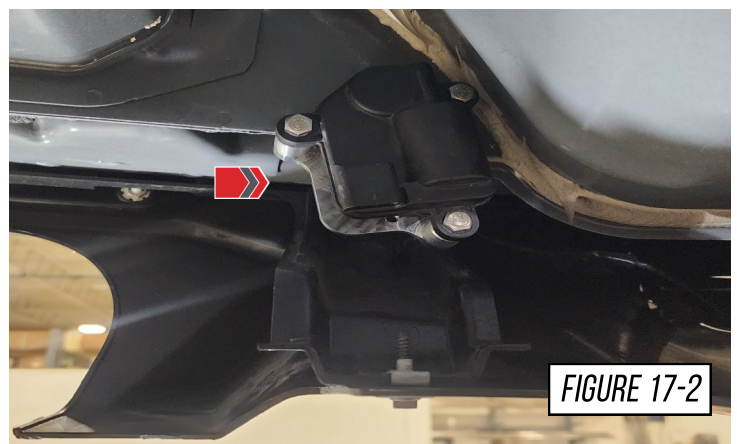
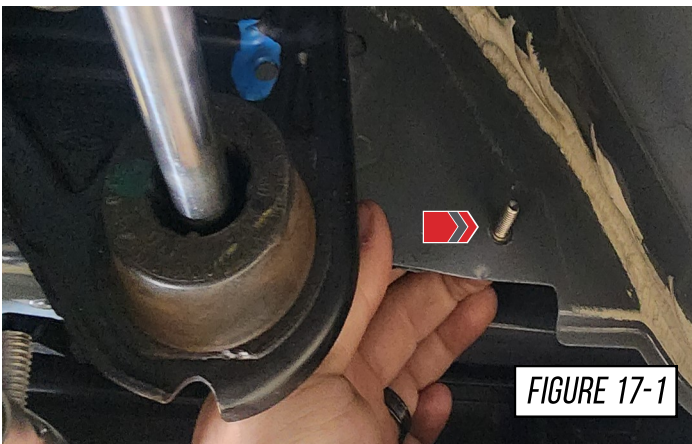

## STEP 18

With the valve simulators have been fully mounted in the car connect your passenger side valve harness to the motor, and the OE plug as shown at (A) in **Figure 18-1**.

Next using a provided cable tie secure the wiring harness slack to the passenger side bumper support, as shown at (B) in **Figure 18-1**.

Now plug the OE wiring harness into the driver side simulator, and OE harness plug as shown at (A) in **Figure 18-2**.

Lastly using a provided cable tie secure the wiring harness slack to the driver side bumper support, as shown at (B) in **Figure 18-2**.



## STEP 19

To install the exhaust tips with integrated clamps, first, attach the exhaust tip in the proper orientation onto the exhaust outlet tube.

Insert one of the carriage bolts from the hardware kit (**3910-41010**) through the tab on the exhaust tip and thread on one of the corresponding nuts.

Using anti-seize on the bolt threads will help installation and prevent breakage of hardware.



If exhaust system only has 2 exhaust tips while the integrated clamp kit has enough hardware for our 4 tip exhaust systems. You will have 2 sets of hardware left over that will not be used.

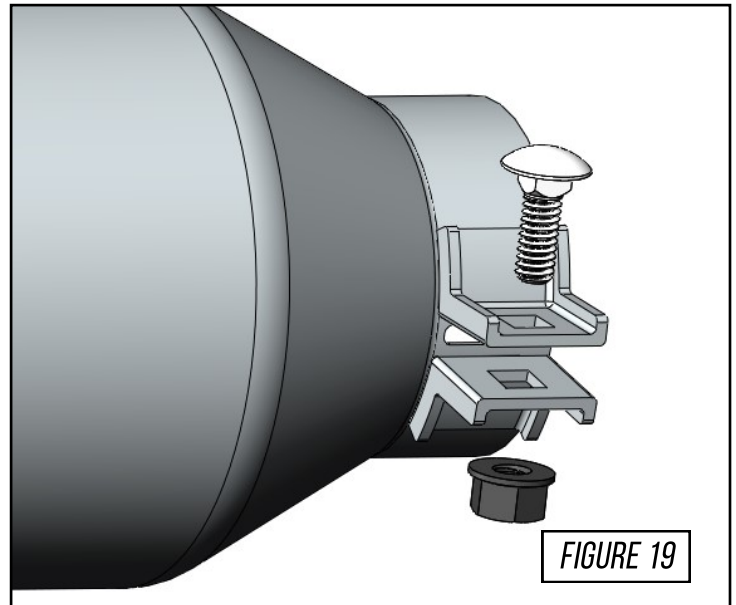

## STEP 20

Now install your four tips onto your exhaust, as shown in **Figure 11**.

With you're your tips installed, work from front clamps back fully tightening all clamps, and bolts. Ensure the tips stay in their desired position.



## STEP 21

With your tips installed, and all clamps fully tightened reinstall the OE rear heat shield using the OE hardware, as shown in **Figure 21**.

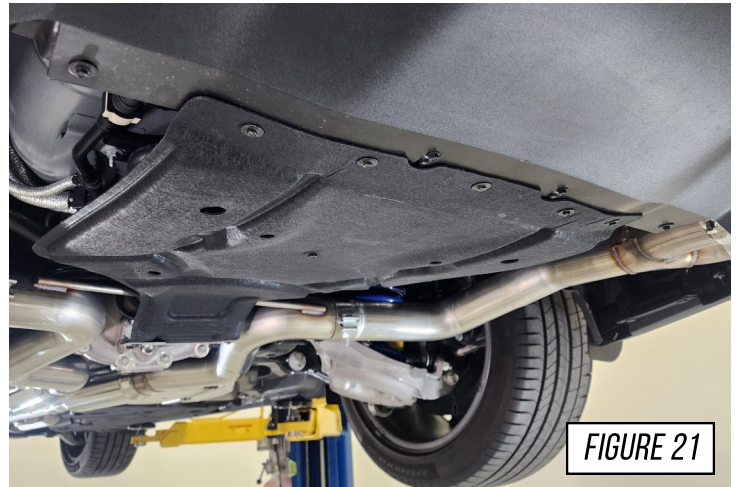



FIGURE 21

## STEP 22

With the complete AWE exhaust system installed, all clamps tightened and the tips aligned. It is now recommended to drive the car to allow the exhaust to heat cycle.

 At this point the exhaust will be **very hot**, allow to cool before work continues.

With the car cooled down, check the tips for correct alignment.

 Don't forget to look below for any troubleshooting needs!



FIGURE 22

# ENJOY!



# TROUBLESHOOTING

Issue	Solution
Exhaust is not fitting correctly	Most fitment issues are due to improperly adjusted exhaust. This includes tip fitments and rattling due to chassis contact. Check out our FAQ/ <a href="#">fitment guide</a> for more installation tips.
Incorrect or missing parts	Double check the parts list for your system and compare them with what you received. Fill out our contact form, found below and let us know what parts you need.

# CARE

Once installed properly, your AWE exhaust will provide years of trouble-free performance.

The exhaust volume and sound will settle with usage; 800-1000 miles is required to break-in new exhaust systems.

Also, please note that the rear **180Technology®** resonator has a small drain hole to allow condensation to escape. Water drops from this area are normal.

Periodic cleaning of exhaust tips is necessary to maintain proper finish, especially in areas prone to road salt and caustic deicing solutions. Use a mild soap and water solution or car wax to clean the finish. Avoid using abrasive polishes, as they can scratch the finish. For best results, we recommend [AWE's Fantastic Tip Tonic](#).

Any questions or comments,  
please do not hesitate to contact us:

**AWE**  
**CONTACT FORM**

# WARRANTY

Up-to-date warranty information is found [HERE](#).